



GIGABOT[®]

*THINK BIG,
PRINT HUGE*

FILAMENT DETECTION
INSTALLATION



INTRODUCTION

THANK YOU FOR PURCHASING THE FILAMENT DETECTION RETROFIT KIT FROM re:3D Inc.®!

This upgrade will let your Gigabot® automatically detect when your filament has run out. It will respond by pausing the print and waiting for the user to manually replace the filament and resume the print. You will find that this is especially helpful for saving prints, reducing wasted filament, and saving time and effort in completing full print jobs.

REFERENCES & HELPFUL DOCUMENTS :

Some external resources may be helpful during the assembly process. For example, knowing the correct names for different parts on the Gigabot®, or proper use of certain tools. Resources that we thought may be helpful have been linked to at the end of this guide.

VIDEO INSTRUCTIONS :

If you prefer a video guide, please search for “re3D Tech” on YouTube and find our “Filament Detection Installation” video.

LEGALESE

READ INSTRUCTIONS : All the safety and operating instructions should be read before the printer is operated.

RETAIN INSTRUCTIONS : The safety and operating instructions should be retained for future reference.

HEED WARNINGS : All warnings on the product and in the operating instructions should be adhered to.

FOLLOW INSTRUCTIONS : All operating and use instructions should be followed.

CLEANING : Unplug this product from the wall outlet before cleaning. Do not use liquid or aerosol cleaners.

ATTACHMENTS : Do not use attachments or enhancements not recommended by the product manufacturer as they may cause hazards.

WATER AND MOISTURE : Do not use Gigabot near water - for example, near a bath tub, wash bowl, kitchen sink, or laundry tub, in a wet basement, or near a swimming pool, and the like.

PLACEMENT : Do not place this product on an unstable cart, stand, tripod, bracket, or table. The product may fall, causing serious injury to a child or adult, and serious damage to the product. Use only with a cart, stand, tripod, bracket, or table recommended by the manufacturer, or sold with the product. Any mounting of the product should follow the manufacturer's instructions, and should use a mounting accessory recommended by the manufacturer.

VENTILATION : Slots and openings in the cabinet are provided for ventilation and to ensure reliable operation of the product and to protect it from overheating, and these openings must not be blocked or covered. The openings should never be blocked by placing the product on a bed, sofa, rug, or other similar surface. This product should not be placed in a built-in installation such as a bookcase or rack unless proper ventilation is provided or the manufacturer's instructions have been adhered to.

POWER SOURCES : This product should be operated only from the type of power source indicated on the marking label. If you are not sure of the type of power supply to your home consult your appliance dealer or local power company. For products intended to operate from battery power, or other sources, refer to the operating instructions.

GROUNDING OR POLARIZATION : This product may be equipped with either a polarized 2-wire AC line plug (a plug having one blade wider than the other) or a 3-wire grounding type plug, a plug having a third (grounding) pin. The 2-wire polarized plug will outlet, try reversing the plug. If the plug still fails to fit, contact your electrician to replace your obsolete outlet. Do not defeat the safety purpose of the polarized plug. The 3-wire grounding type plug will fit into a grounding type power outlet. This is a safety feature. If you are unable to insert the plug into the outlet, contact your electrician to replace your obsolete outlet. Do not defeat the safety purpose of the grounding type plug.

POWER-CORD PROTECTION : Power-supply cords should be routed so that they are not likely to be walked on or pinched by items placed upon or against them, paying particular attention to cords at plugs, convenience receptacles, and the point where they exit from the product.

LIGHTNING : For added protection for this product during a lightning storm, or when it is left unattended and unused for long periods of time, unplug it from the wall outlet and disconnect the antenna or cable system. This will prevent damage to the product due to lightning and power-line surges.

OVERLOADING : Do not overload wall outlets, extension cords, or integral convenience receptacles as this can result in a risk of fire or electric shock. A product and cart combination should be moved with care. Quick stops, excessive force, and uneven surfaces may cause the product and cart combination to overturn.

OBJECT AND LIQUID ENTRY : Never push objects of any kind into this product through openings as they may touch dangerous voltage points or short-out parts that could result in a fire or electric shock. Never spill liquid of any kind on the product.

TABLE OF CONTENTS

OVERVIEW	1
FIRMWARE NOTE	2
LEGEND	3
BEFORE YOU BUILD	4
TOOLS YOU'LL NEED	6
BUILD GUIDE	7
BILL OF MATERIALS - SINGLE EXTRUDER	7
BILL OF MATERIALS - DUAL EXTRUDER	8
A : REMOVAL	9
B : ADDING PANDUITS	11
C : INSTALL FILAMENT DETECTION	13
D : WIRING	16

OVERVIEW

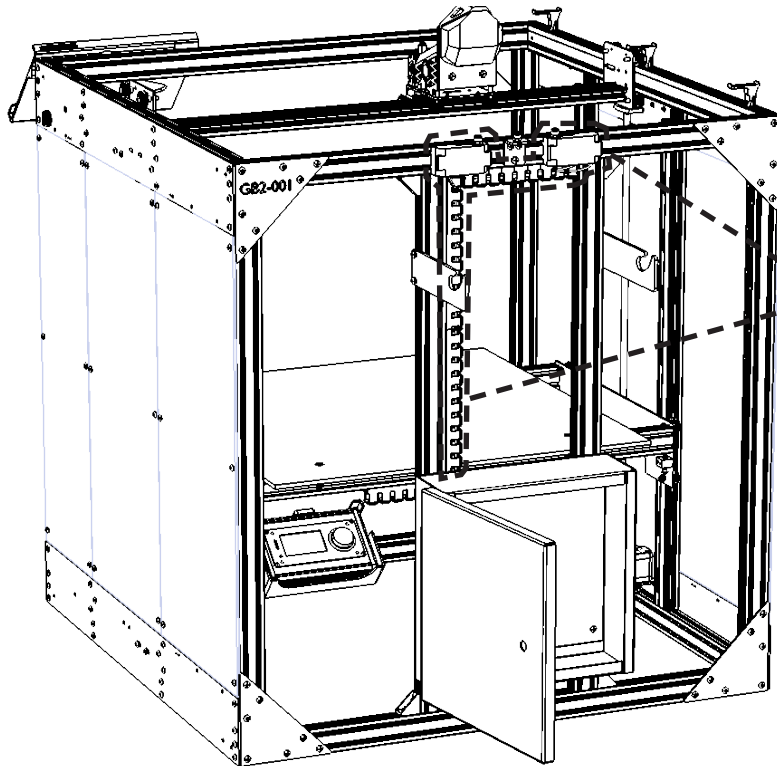

Filament detection with added Panduits

Back of Gigabot

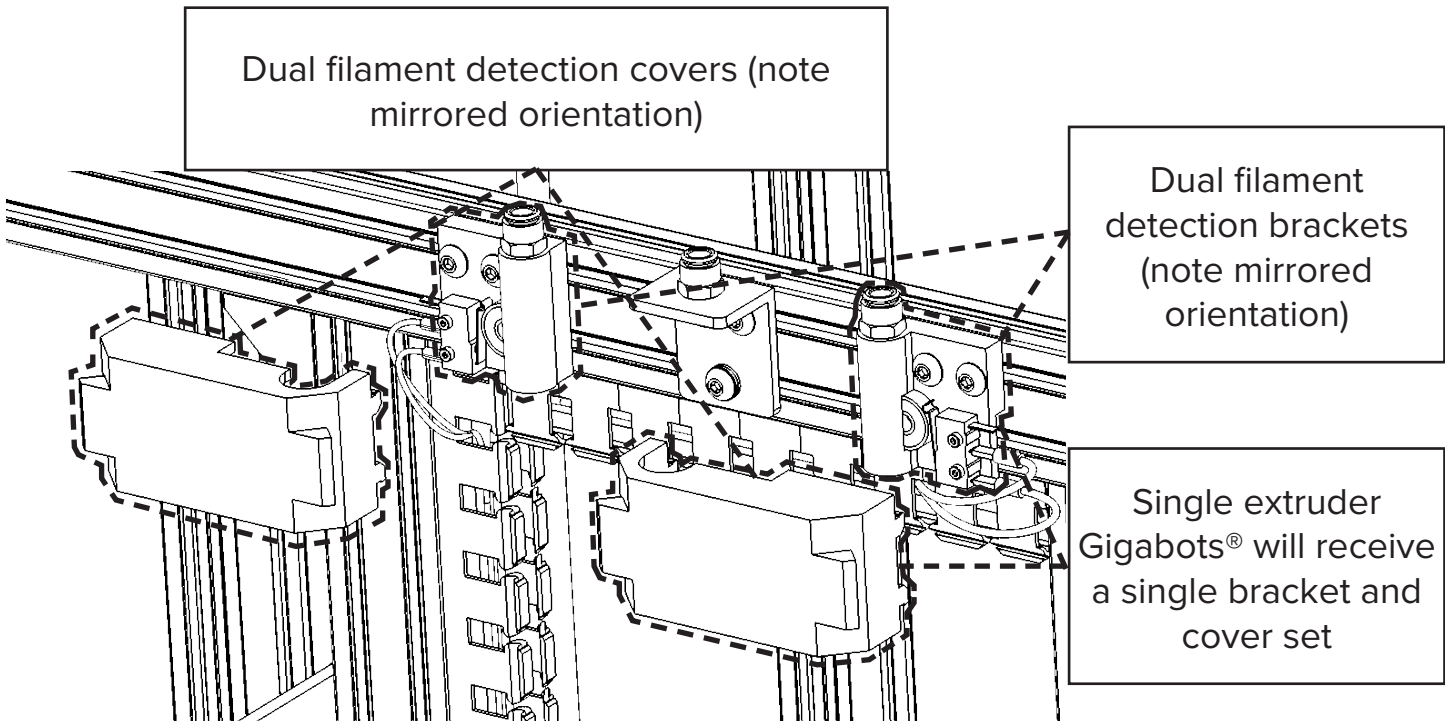

Dual filament detection covers (note mirrored orientation)

Dual filament detection brackets (note mirrored orientation)

Single extruder Gigabots® will receive a single bracket and cover set

**Full Gigabot rendering is for illustrative purposes only and may not reflect the final construction of your Gigabot*

FIRMWARE NOTE

Installing this upgrade will require a firmware update for your Gigabot's® Azteeg. This manual only includes instructions for installing the physical components. Please refer to our wiki (wiki.re3d.org) for instructions in updating firmware.

Filament detection is only active while the associated hot end is also active.

When filament detection is triggered during operation:

- Extruder performs a small retraction
- Bed lowers slightly
- Print head moves to the front and center of the Gigabot®
- Extruder performs a long retraction
- Hot end heater is automatically turned off, while the bed heater remains on
- User must remove remaining filament from the filament tube
- Then insert new filament into filament tube
- Press center button on Viki (this will turn the hot end heater back on)
- Once hot end is up to temperature, click center button again to activate extruder
- Rotating the Viki wheel engages the extruder feed. Feed filament until extrusion is verified
- Click center button to resume print

LEGEND

REMOVE



DISCONNECT

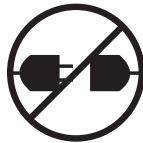

EVENLY SPACE



INSERT

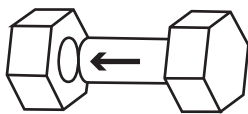

PLACE



LOCATE



FASTEN/SCREW

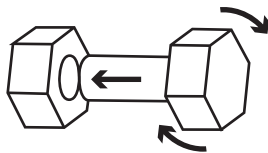

CONNECT



ROUTE



UNFASTEN/UNSCREW

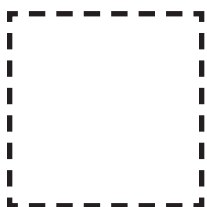
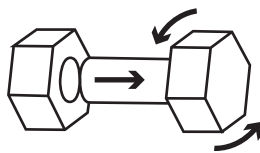

Objects of importance are outlined with dotted lines

BEFORE YOU BUILD

IT'S HIP TO BE SQUARE!

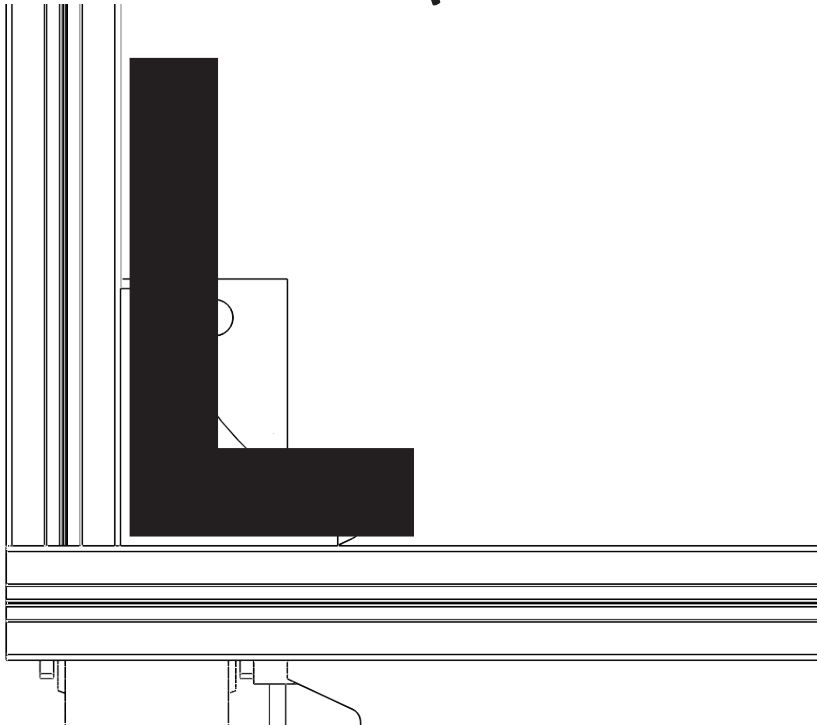

When assembling the Gigabot®, it is essential to work on a flat surface and to carefully square perpendicular parts as much as possible. This is especially important while assembling the side plates, Z-axis uprights and vertical common rails, bed frame, upper and lower cross rails, and bridge assembly. Use large clamps to help square up frames if needed.

THE USES OF GREASE

Make good use of grease during assembly. These will help hold the eccentric spacers when installing the V-groove wheels and also keep them from damaging the side plates or end trucks during adjustment. Likewise, it will ensure smooth, quiet operation when applied to the Z-axis ACME threaded rods.

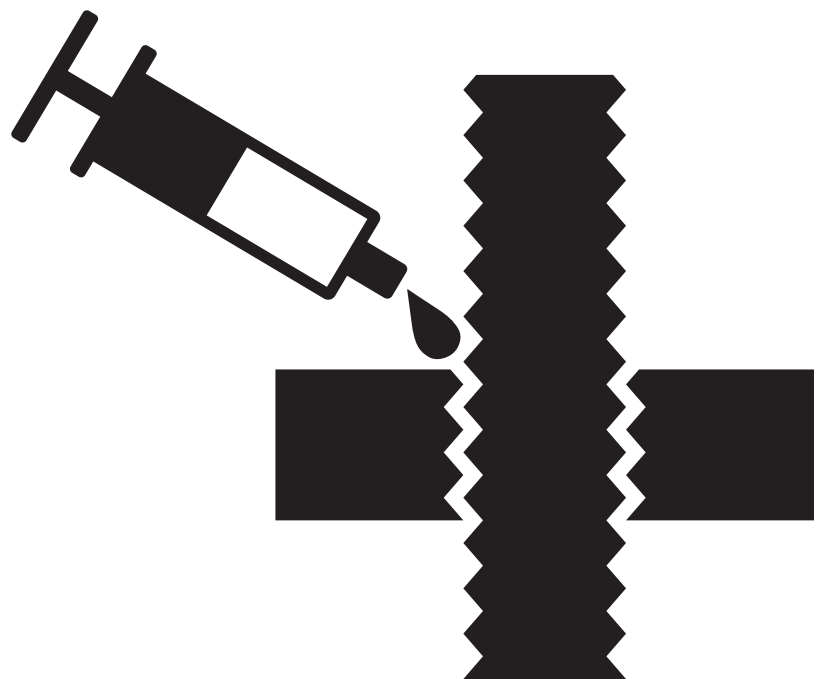

T-NUTS, HOW DO THEY WORK?

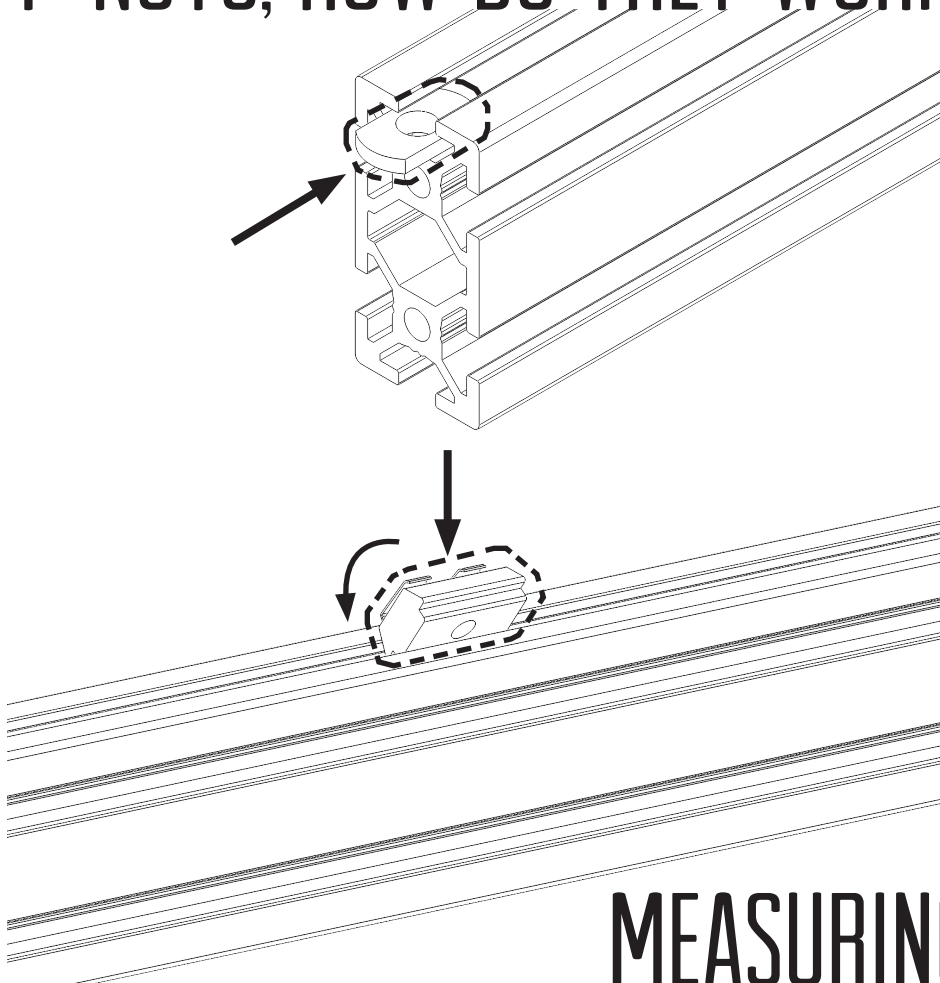

T-nuts are an essential part of assembling the Gigabot®. These are inserted into the aluminum extrusion in order to fasten parts to the frame. Post assembly T-nuts are also used. These hold their positions well without sliding around, and are useful when installing retrofits.

MEASURING AND MARKING

There may be parts of the instructions that suggest marking spots on the Gigabot® to properly place parts. When marking, be sure to only use a pencil--using a permanent marker will leave unsightly marks on the metal!



TOOLS YOU'LL NEED

- 3MM ALLEN KEY
- NEEDLE NOSE PLIERS

BUILD GUIDE

BILL OF MATERIALS - SINGLE EXTRUDER

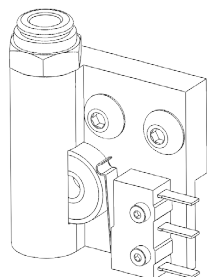

Preassembled bracket with hardware 1

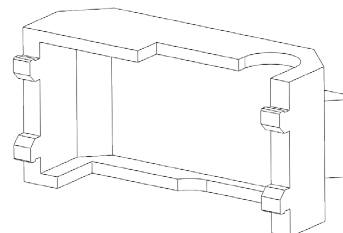

3D printed cover 1

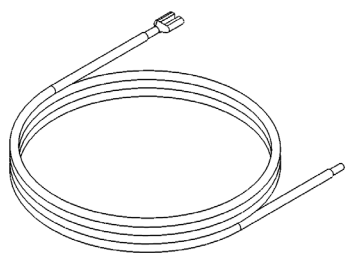

Limit switch wire 1

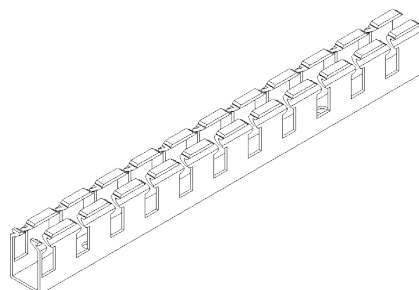

Short, deep Panduit** 1

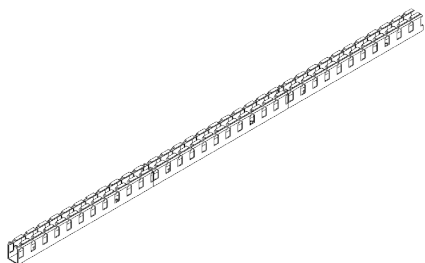

30"/762 deep Panduit** 1

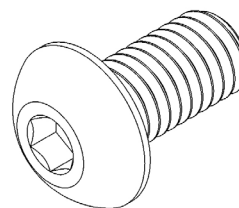

M5x12mm BHCS 2

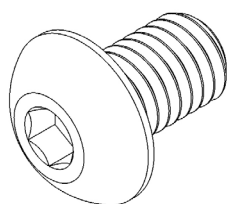

M5x8mm BHCS 4

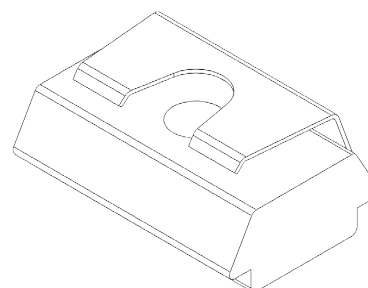

Post assembly T-nuts 6

BILL OF MATERIALS - DUAL EXTRUDER

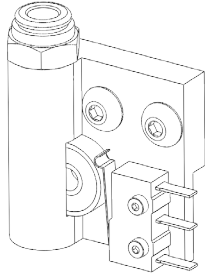

Preassembled bracket with hardware* 2

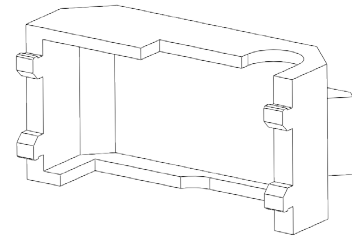

3D printed cover* 2

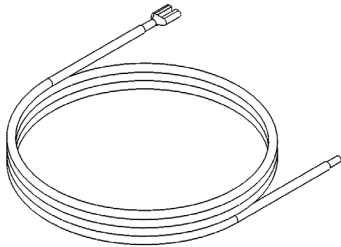

Limit switch wire 2

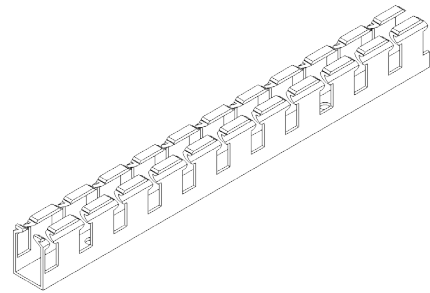

Short, deep Panduit** 1

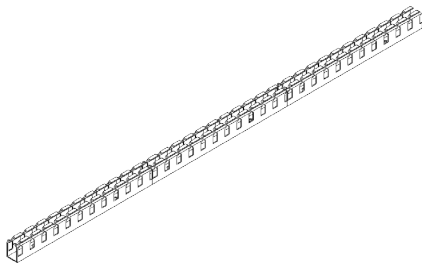

Long, deep Panduit** 1

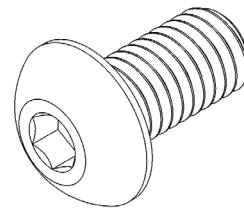

M5x12mm BHCS 4

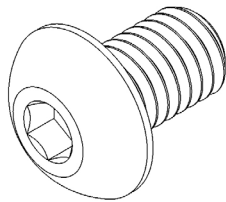

M5x8mm BHCS 4

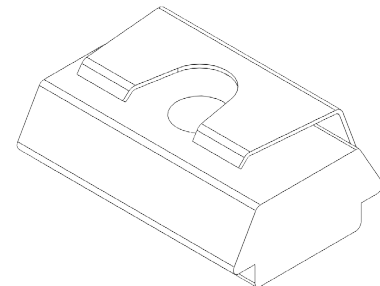

Post assembly T-nuts 8

*For dual extruders, one bracket/cover set will be mirrored.

**All Panduits include covers

A : REMOVAL

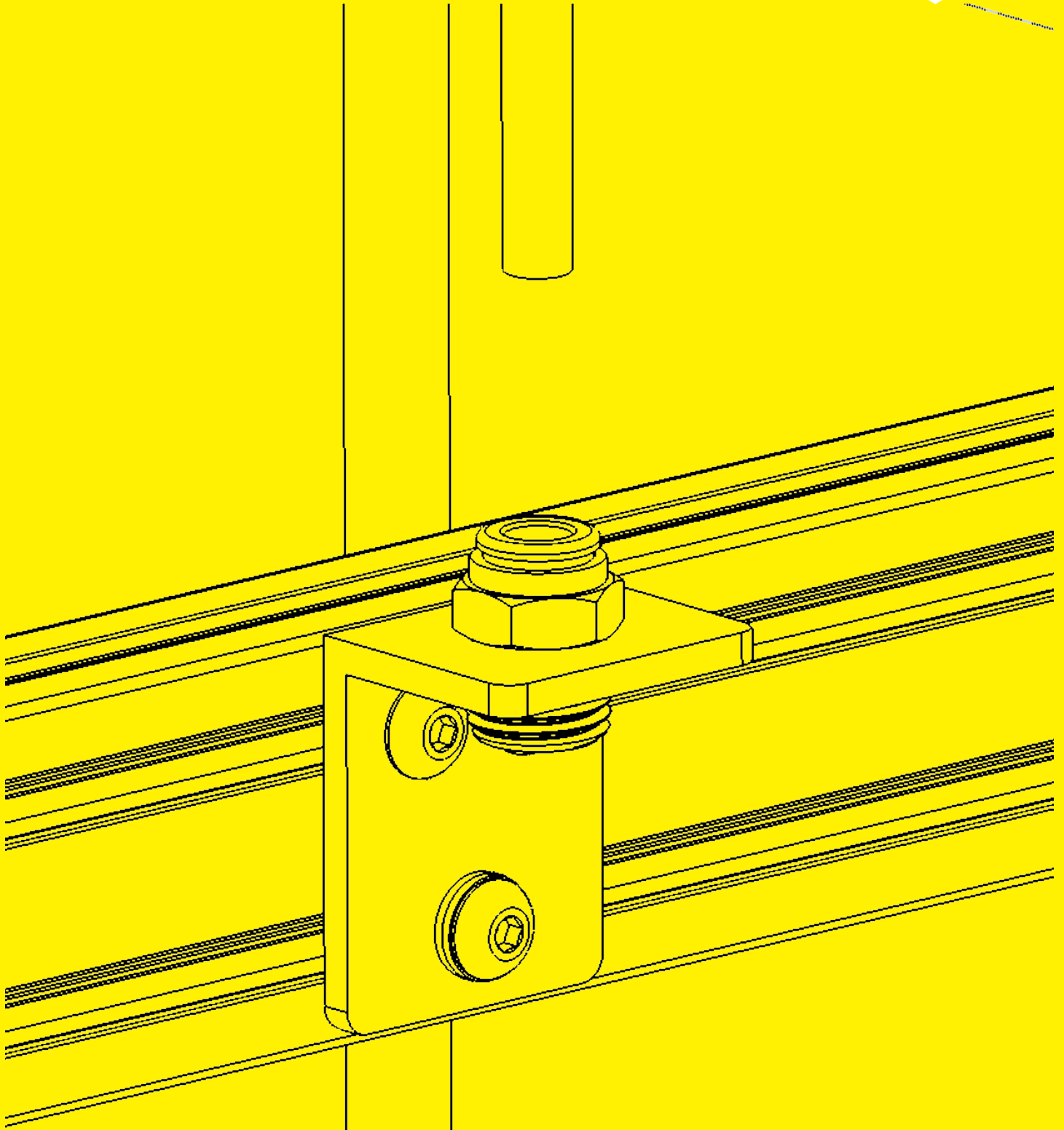

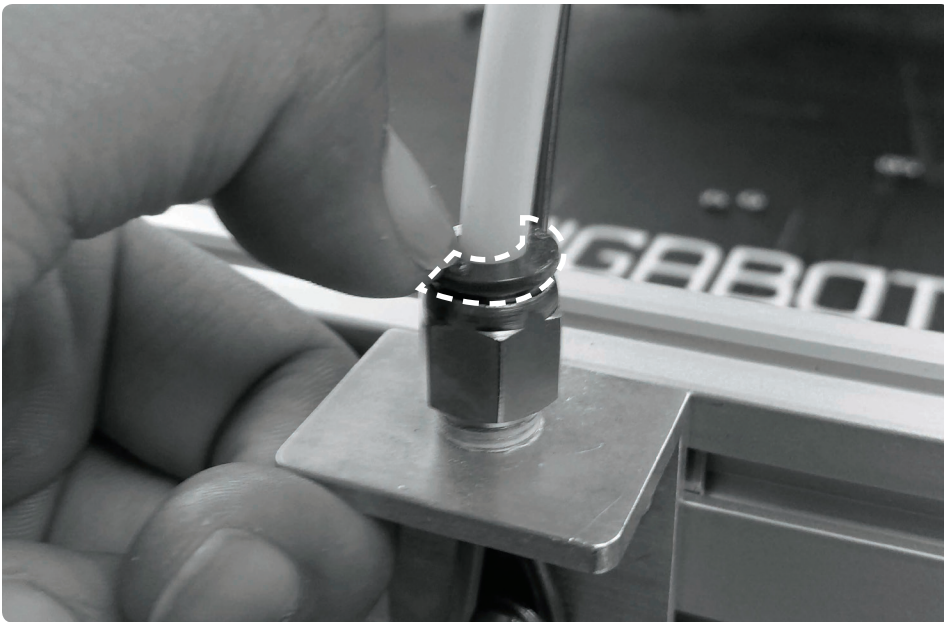

A1



Remove filament tube from push fit connector on rear filament shelf by holding down the blue ring and pulling out the filament tube

Use pliers to pull out tube if needed



A2

Leave rear filament shelf in place to make use of rear filament rod

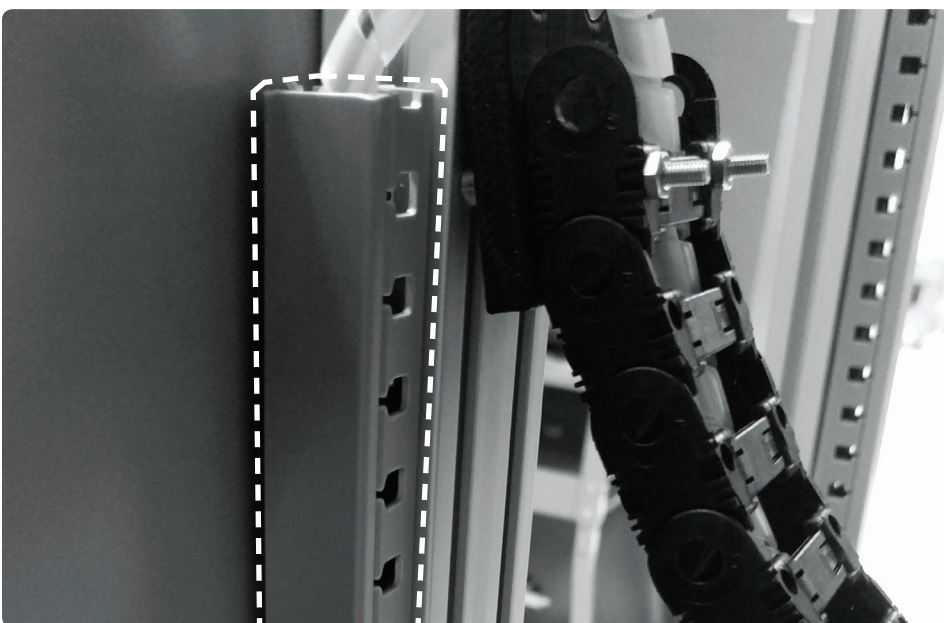

A3



If using cable carrier upgrades, remove small Panduit on rear vertical support rail for Z-axis cable carrier

B : ADDING PANDUITS

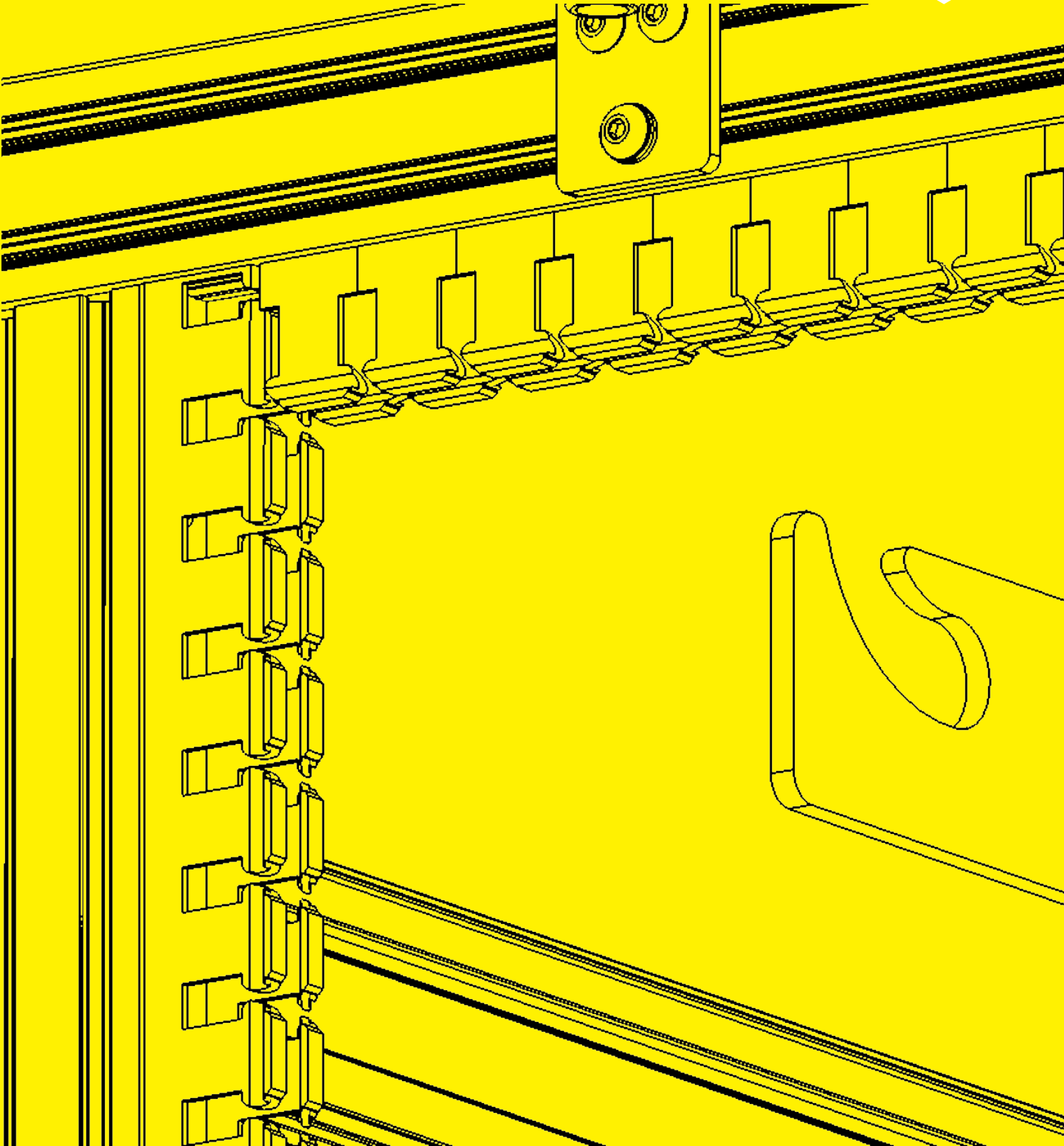



B1



Evenly space and insert T-nuts along top back cross rail and right support rail



B2



Place corresponding Panduits and fasten M5x8mm BHCS using 3mm Allen Key

C : INSTALL FILAMENT DETECTION

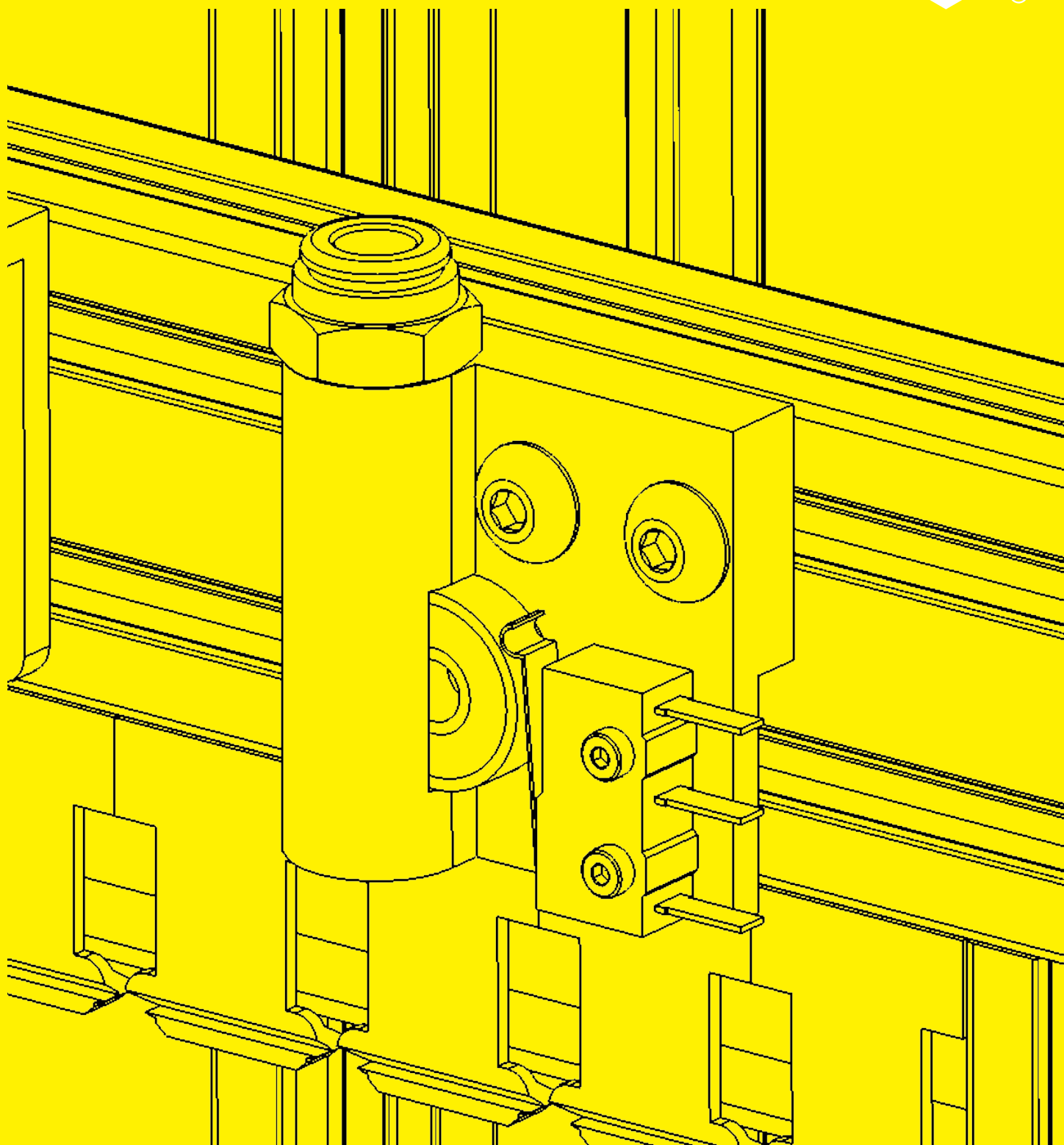

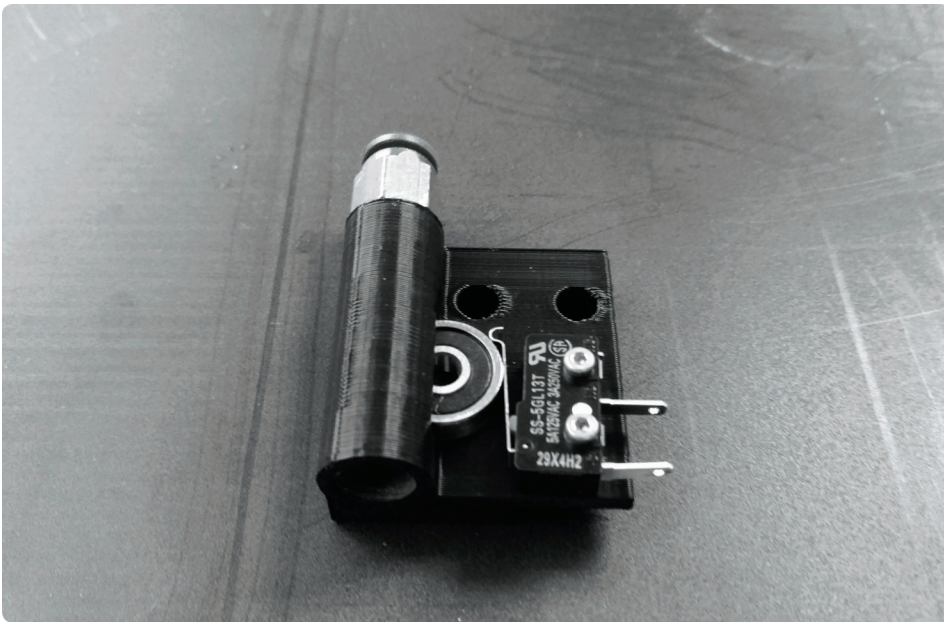

C1

The 3D printed bracket will include all necessary components for filament detection

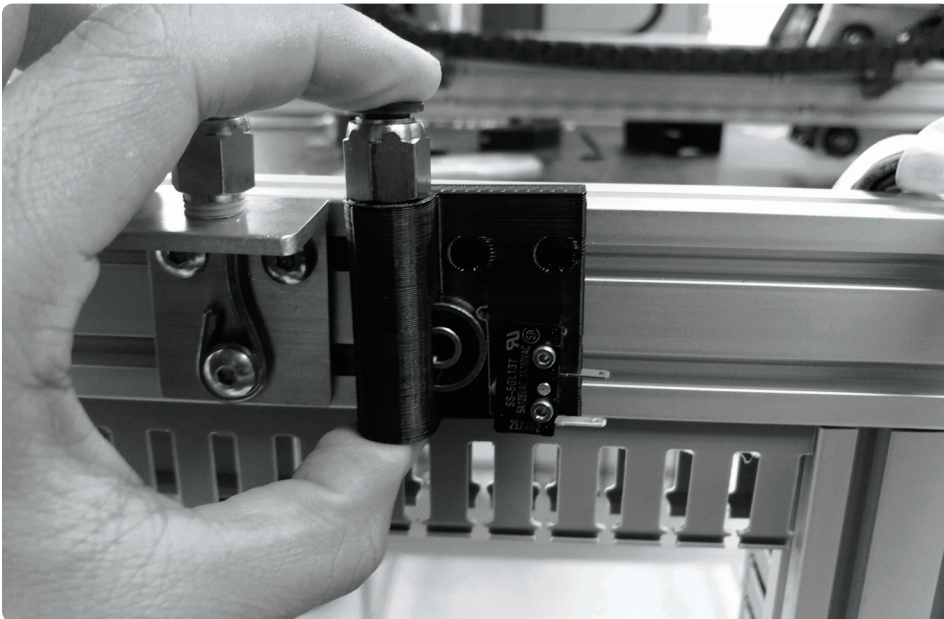

C2



Locate this bracket near the filament spool

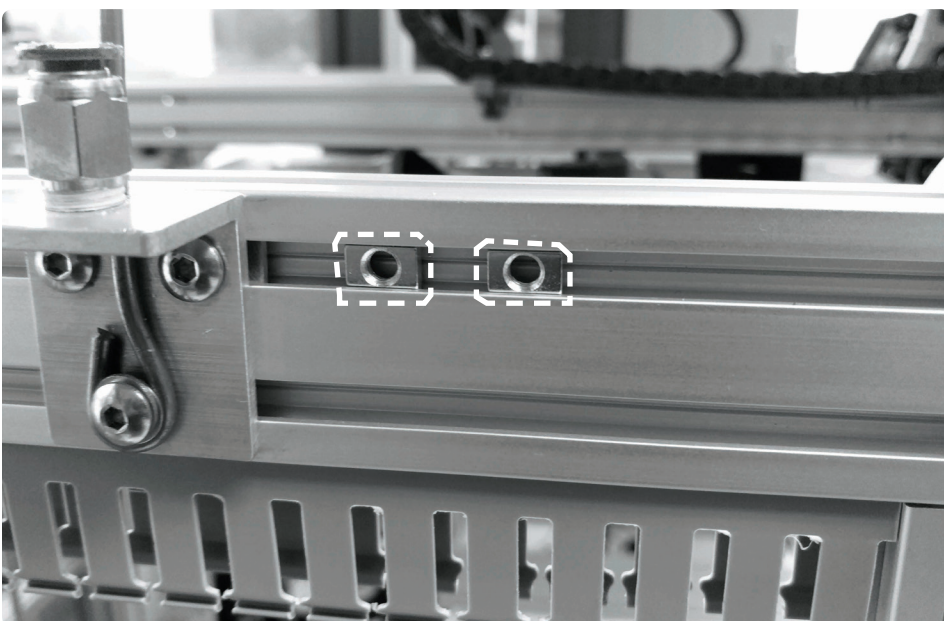

C3

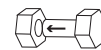

Insert the T-nuts into the rail

C4

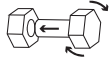

Fasten the bracket with 2
M5x12mm BHCS using the
3mm Allen Key

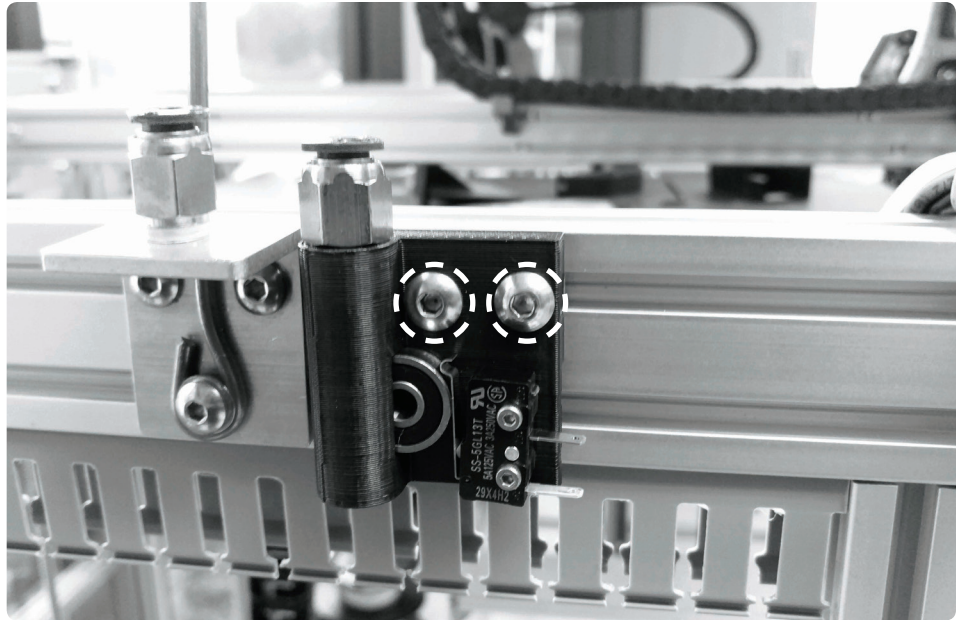

C5

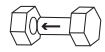

Push filament tube all the
way into push fit connector

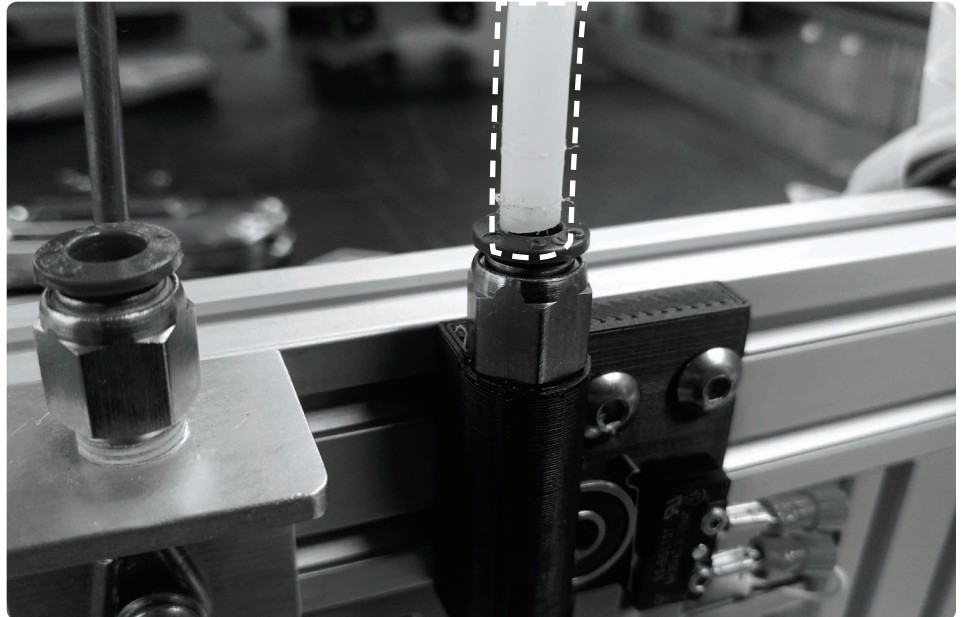

D : WIRING

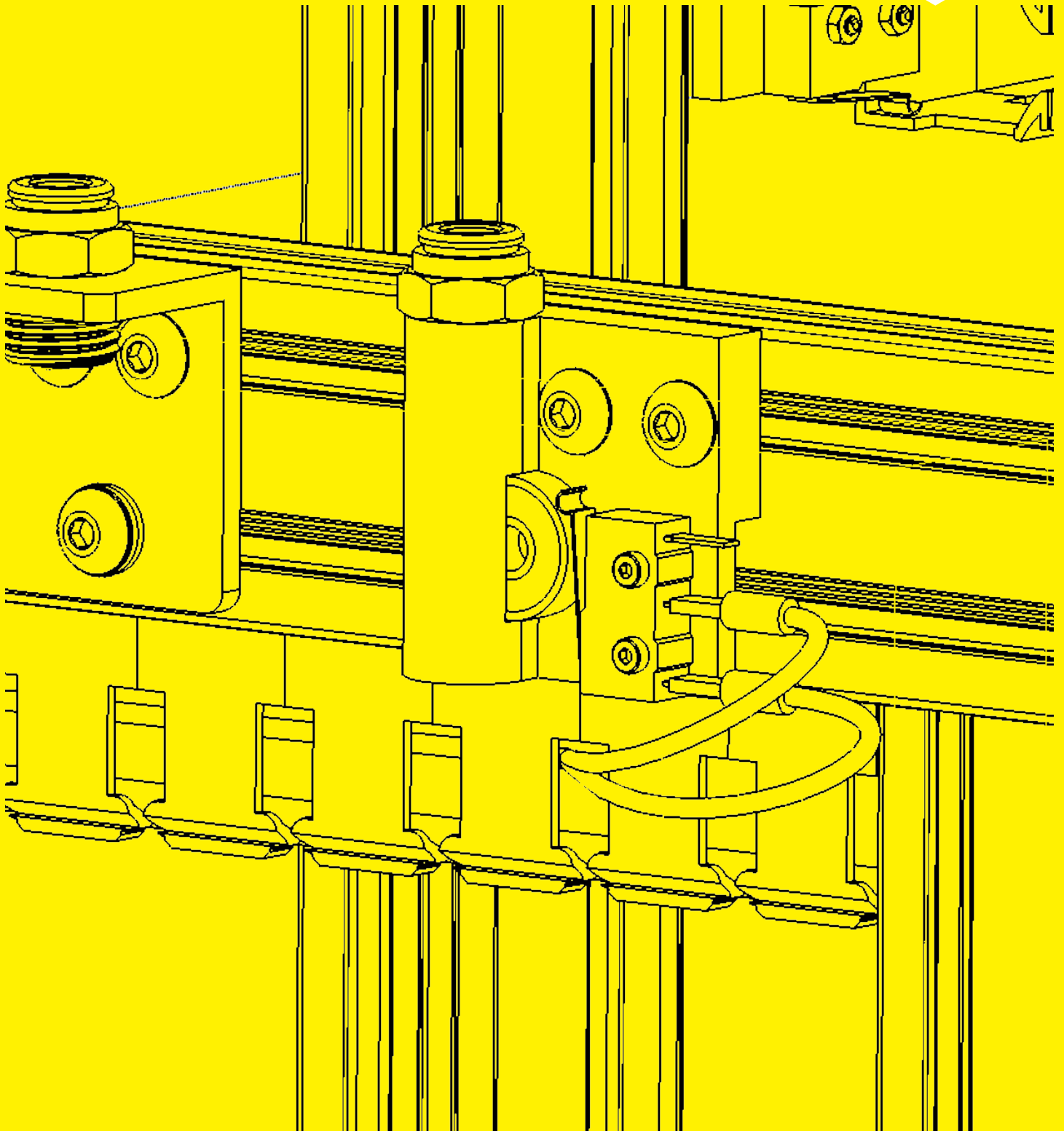

WARNING

PLEASE be sure that you have turned off and unplugged your Gigabot before attempting any modifications!

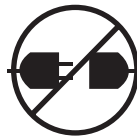

D2



Plug wires into limit switch

Dual extruder kits will be labeled “FD1” and “FD2” to distinguish between extruders (left extruder is 1, right extruder is 2)

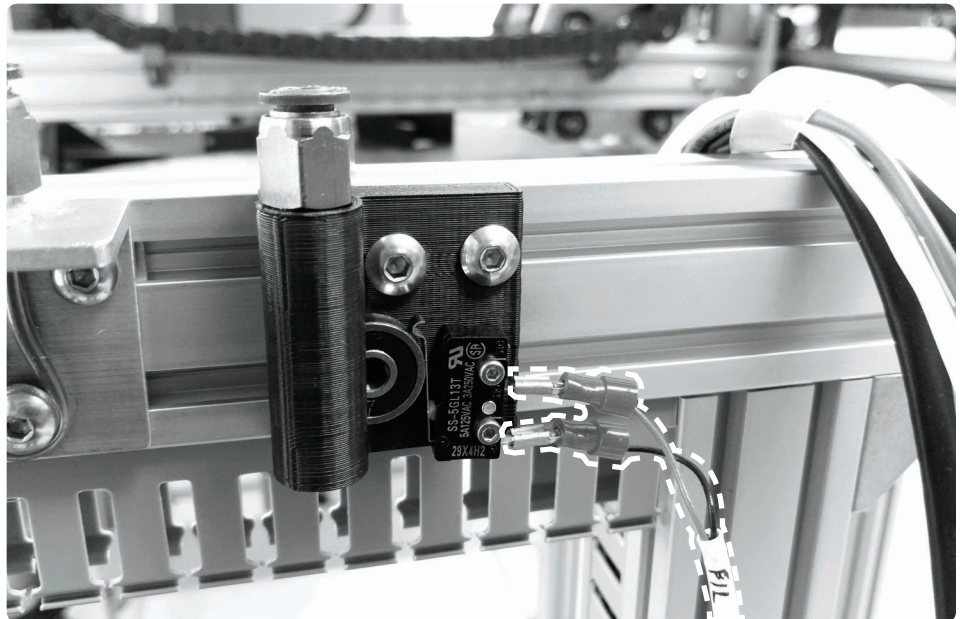

D3



Route wires through Panduits

Place Panduit covers along the way



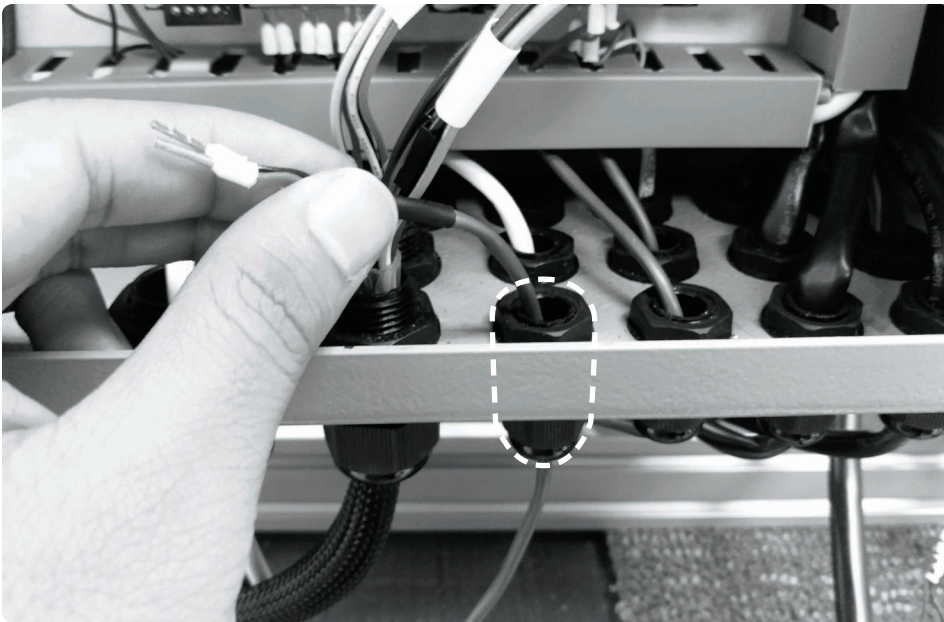

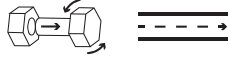
D4 

Route the wires through an available electrical box grommet

Loosen grommet cap and route the wires through one wire at a time



D5 

Connect wires to Azteeg according to wiring diagram

Wiring will differ depending on Gigabot® version. Please refer to wiring diagrams or contact re:3D Inc.® support for help

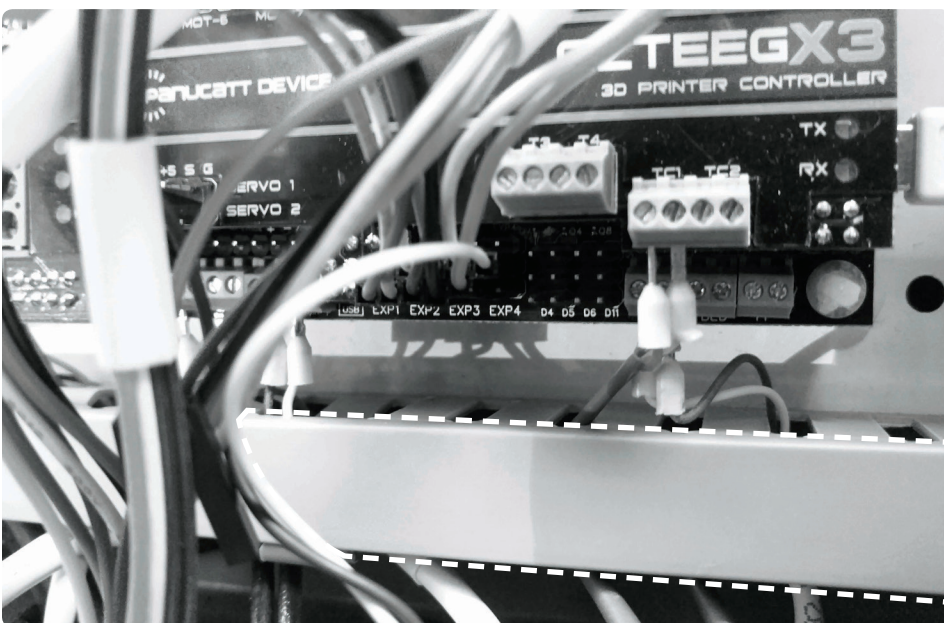

D6 

If needed, neatly route wires through electrical box Panduits and cover

D7

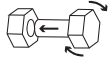

Tighten grommet cap



D8



Snap filament detection cover into place

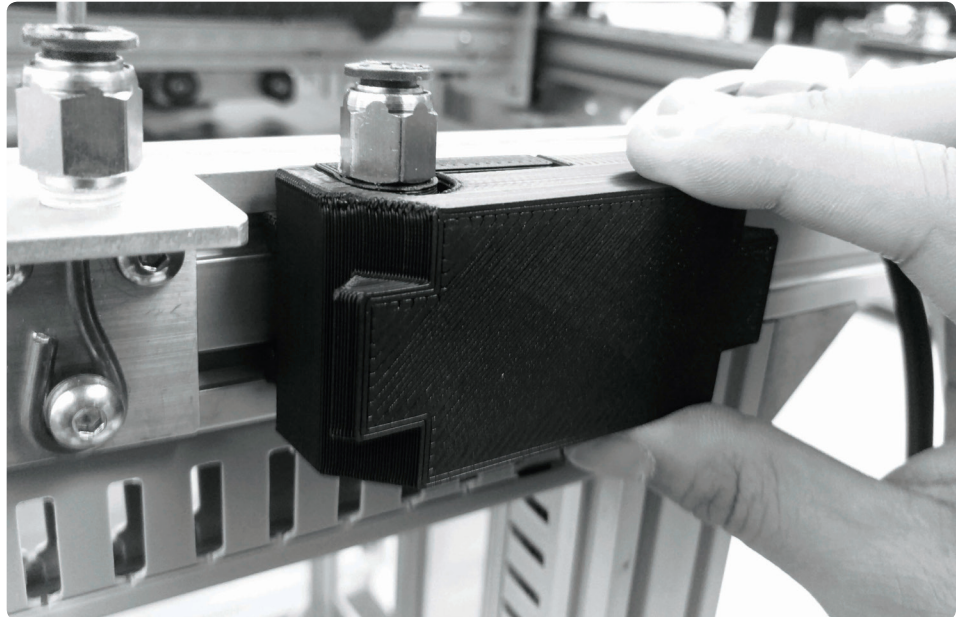

D9

Process is the same for dual. Install bracket, wire through existing Panduit, and connect to Azteeg according to diagram

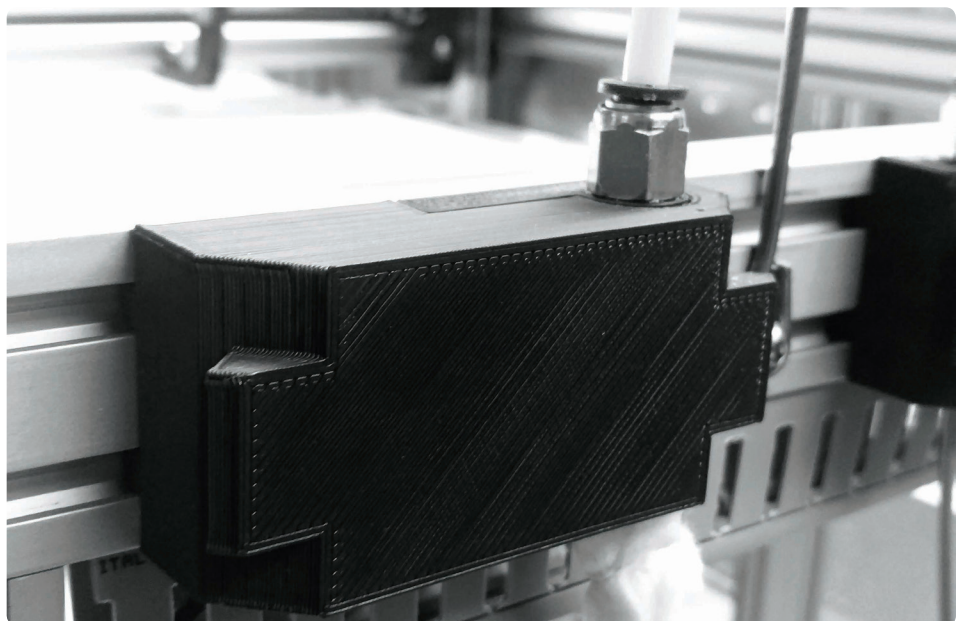

DOUBLE-CHECK YOUR WORK :

Please look over your completed kit and make sure everything has been assembled correctly. If you have further questions, please refer to the video instructions (search “re3D Tech” on YouTube and find “Filament Detection Installation” video) or contact us through the references listed in the conclusion.

NOW IS A GOOD STOPPING POINT...

Acquire beverage of
your choice

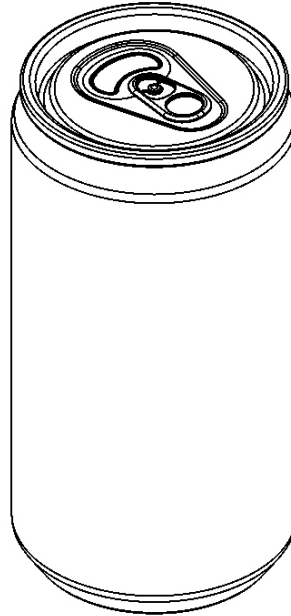

Actuate pull tab

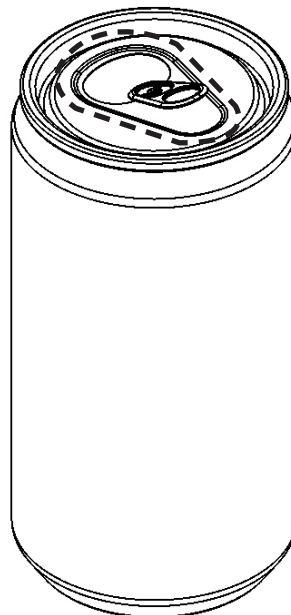

Consume

CONCLUSION

CONGRATULATIONS! YOU HAVE NOW COMPLETED THE FILAMENT DETECTION RETROFIT ON YOUR GIGABOT®.

We are confident that you will find this upgrade very helpful in your every day use of the Gigabot®, but please do not hesitate to contact us for any further issues or questions. Feedback on assembly instructions, support, and other aspects of your experience are welcome. Reach out to us at:

WIKI : wiki.re3d.org

EMAIL : support@re3d.org

PHONE : 512-730-0033

Happy printing!

THINK BIG, PRINT HUGE!

From the re:3D Inc.® team

REFERENCES & DOCUMENTS

**FILAMENT DETECTION
INSTALLATION
MANUAL PDF :**

http://wiki.re3d.org/index.php?title=Retrofit_Instructions

**re:3D Inc.® YouTube
CHANNEL :**

<https://www.youtube.com/user/GigaBot3D>

**GIGABOT® AZTEEG
WIRING DIAGRAM
(bottm of page):**

http://wiki.re3d.org/index.php?title=Retrofit_Instructions

WIRING : GIGABOT® WITH WIKI 2 & AZTEEG 2.0

For other configurations, please check our Wiki site, linked in the previous page.

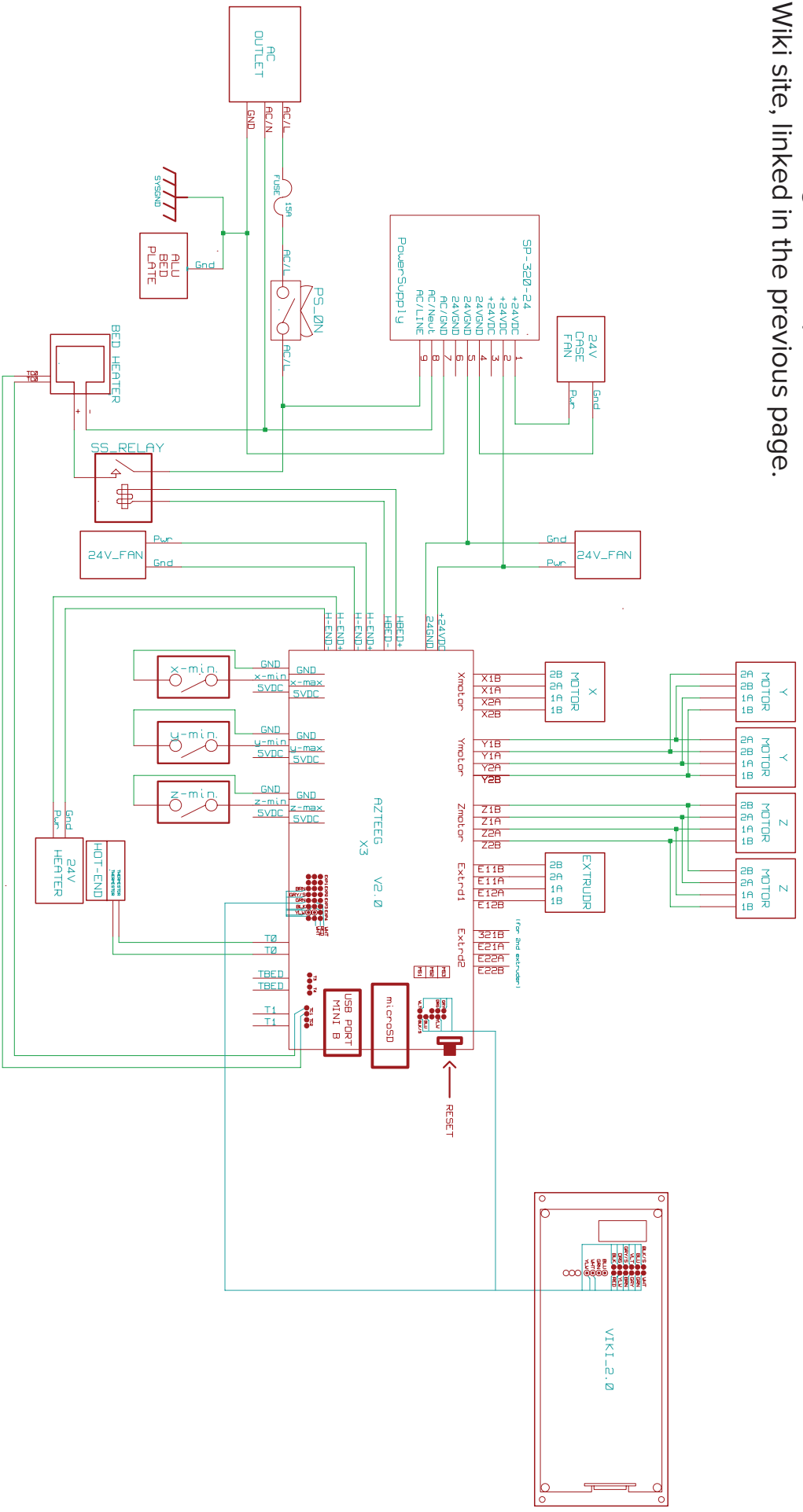



re:3D Inc.® | re3d.org | support@re3d.org