



GIGABOT[®]

THINK BIG,
PRINT HUGE

VIKI 2.0
INSTALLATION



INTRODUCTION

THANK YOU FOR PURCHASING THE VIKI 2.0 INSTALLATION RETROFIT KIT FROM re:3D Inc.®!

This upgrade will let you replace your old Viki LCD with the newer Viki 2.0 LCD. You will find that this is especially helpful for using and controlling your Gigabot® without connecting to a computer. Unlike its predecessor, the Viki 2.0 also sports a new black faceplate and provides better visual indication of print conditions with new features like a dual-color LED ring around the knob.

REFERENCES & HELPFUL DOCUMENTS :

Some external resources may be helpful during the assembly process. For example, knowing the correct names for different parts on the Gigabot®, or proper use of certain tools. Resources that we thought may be helpful have been linked to at the end of this guide.

VIDEO INSTRUCTIONS :

If you prefer a video guide, please search for “re3D Tech” on YouTube and find our “Viki 2.0 Installation” video.

LEGALESE

READ INSTRUCTIONS : All the safety and operating instructions should be read before the printer is operated.

RETAIN INSTRUCTIONS : The safety and operating instructions should be retained for future reference.

HEED WARNINGS : All warnings on the product and in the operating instructions should be adhered to.

FOLLOW INSTRUCTIONS : All operating and use instructions should be followed.

CLEANING : Unplug this product from the wall outlet before cleaning. Do not use liquid or aerosol cleaners.

ATTACHMENTS : Do not use attachments or enhancements not recommended by the product manufacturer as they may cause hazards.

WATER AND MOISTURE : Do not use Gigabot near water - for example, near a bath tub, wash bowl, kitchen sink, or laundry tub, in a wet basement, or near a swimming pool, and the like.

PLACEMENT : Do not place this product on an unstable cart, stand, tripod, bracket, or table. The product may fall, causing serious injury to a child or adult, and serious damage to the product. Use only with a cart, stand, tripod, bracket, or table recommended by the manufacturer, or sold with the product. Any mounting of the product should follow the manufacturer's instructions, and should use a mounting accessory recommended by the manufacturer.

VENTILATION : Slots and openings in the cabinet are provided for ventilation and to ensure reliable operation of the product and to protect it from overheating, and these openings must not be blocked or covered. The openings should never be blocked by placing the product on a bed, sofa, rug, or other similar surface. This product should not be placed in a built-in installation such as a bookcase or rack unless proper ventilation is provided or the manufacturer's instructions have been adhered to.

POWER SOURCES : This product should be operated only from the type of power source indicated on the marking label. If you are not sure of the type of power supply to your home consult your appliance dealer or local power company. For products intended to operate from battery power, or other sources, refer to the operating instructions.

GROUNDING OR POLARIZATION : This product may be equipped with either a polarized 2-wire AC line plug (a plug having one blade wider than the other) or a 3-wire grounding type plug, a plug having a third (grounding) pin. The 2-wire polarized plug will outlet, try reversing the plug. If the plug still fails to fit, contact your electrician to replace your obsolete outlet. Do not defeat the safety purpose of the polarized plug. The 3-wire grounding type plug will fit into a grounding type power outlet. This is a safety feature. If you are unable to insert the plug into the outlet, contact your electrician to replace your obsolete outlet. Do not defeat the safety purpose of the grounding type plug.

POWER-CORD PROTECTION : Power-supply cords should be routed so that they are not likely to be walked on or pinched by items placed upon or against them, paying particular attention to cords at plugs, convenience receptacles, and the point where they exit from the product.

LIGHTNING : For added protection for this product during a lightning storm, or when it is left unattended and unused for long periods of time, unplug it from the wall outlet and disconnect the antenna or cable system. This will prevent damage to the product due to lightning and power-line surges.

OVERLOADING : Do not overload wall outlets, extension cords, or integral convenience receptacles as this can result in a risk of fire or electric shock. A product and cart combination should be moved with care. Quick stops, excessive force, and uneven surfaces may cause the product and cart combination to overturn.

OBJECT AND LIQUID ENTRY : Never push objects of any kind into this product through openings as they may touch dangerous voltage points or short-out parts that could result in a fire or electric shock. Never spill liquid of any kind on the product.

TABLE OF CONTENTS

OVERVIEW	1
LEGEND	2
BEFORE YOU BUILD	3
BUILD GUIDE	5
BILL OF MATERIALS	5
TOOLS YOU'LL NEED	5
A : VIKI REPLACEMENT	6



OVERVIEW

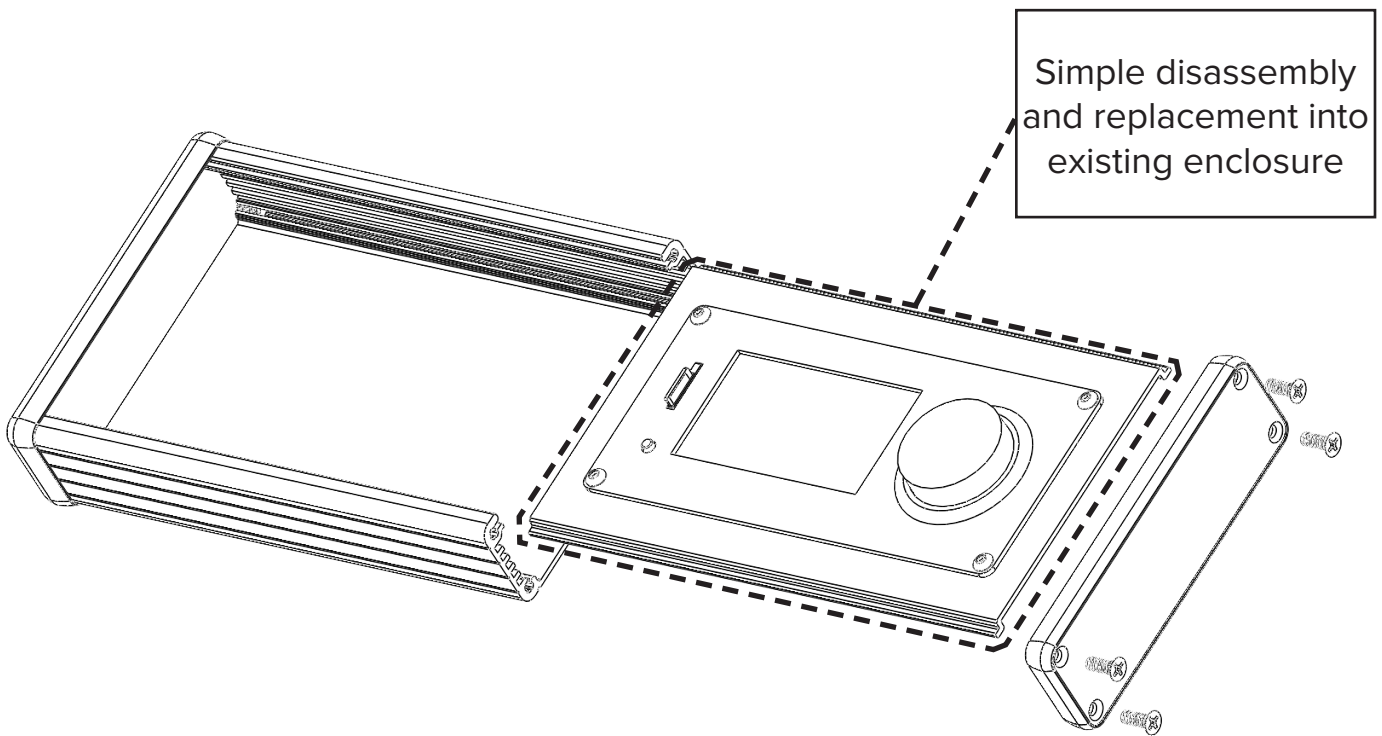
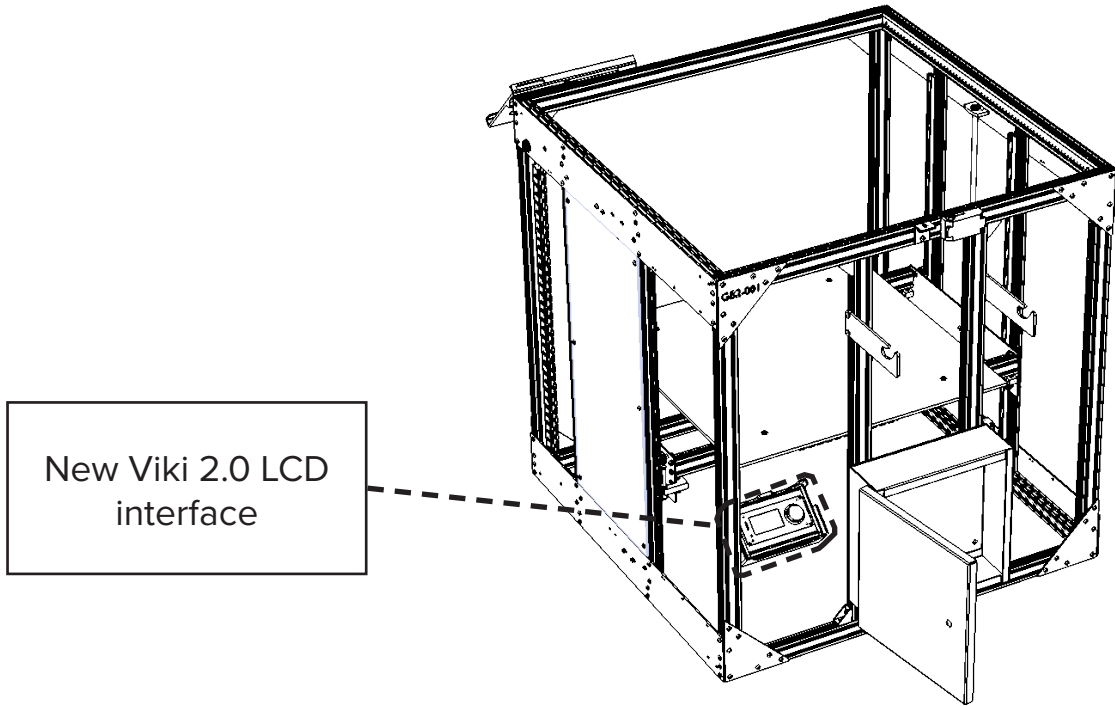

**Full Gigabot® rendering is for illustrative purposes only and may not reflect the final construction of your Gigabot®*

LEGEND

DISCONNECT



CONNECT



UNFASTEN/UNSCREW

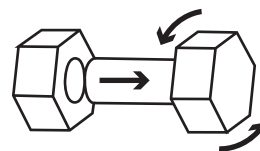

FASTEN/SCREW

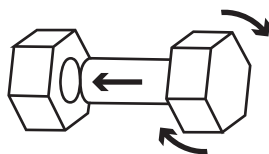

INSERT

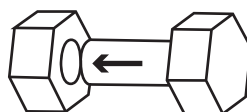

PLACE

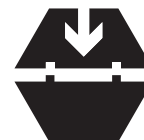

REMOVE



ROUTE

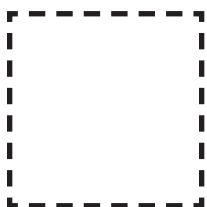

Objects of importance are outlined with dotted lines

BEFORE YOU BUILD

IT'S HIP TO BE SQUARE!



When assembling the Gigabot®, it is essential to work on a flat surface and to carefully square perpendicular parts as much as possible. This is especially important while assembling the side plates, Z-axis uprights and vertical common rails, bed frame, upper and lower cross rails, and bridge assembly. Use large clamps to help square up frames if needed.

Make good use of grease during assembly. These will help hold the eccentric spacers when installing the V-groove wheels and also keep them from damaging the side plates or end trucks during adjustment. Likewise, it will ensure smooth, quiet operation when applied to the Z-axis ACME threaded rods.

THE USES OF GREASE

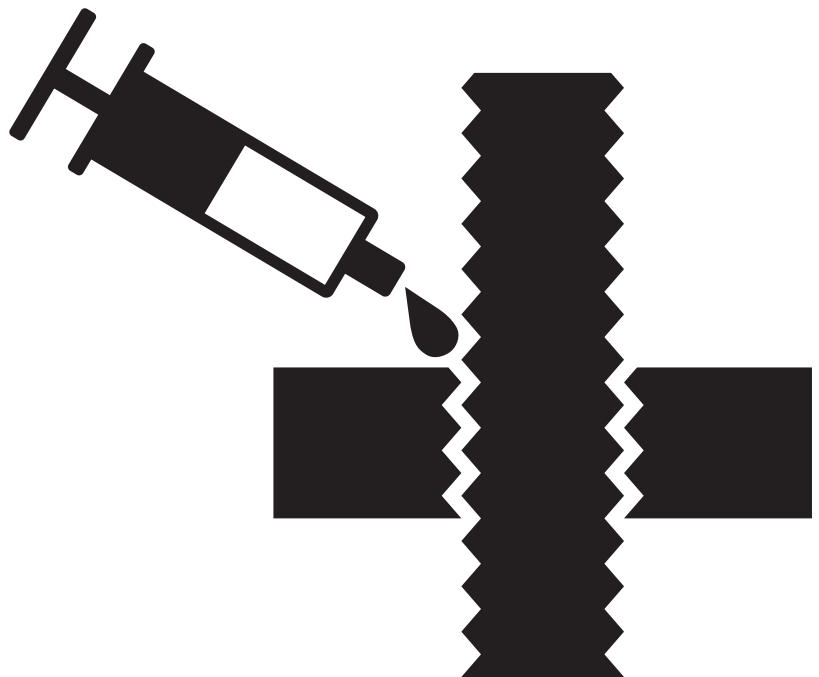

T-NUTS, HOW DO THEY WORK?

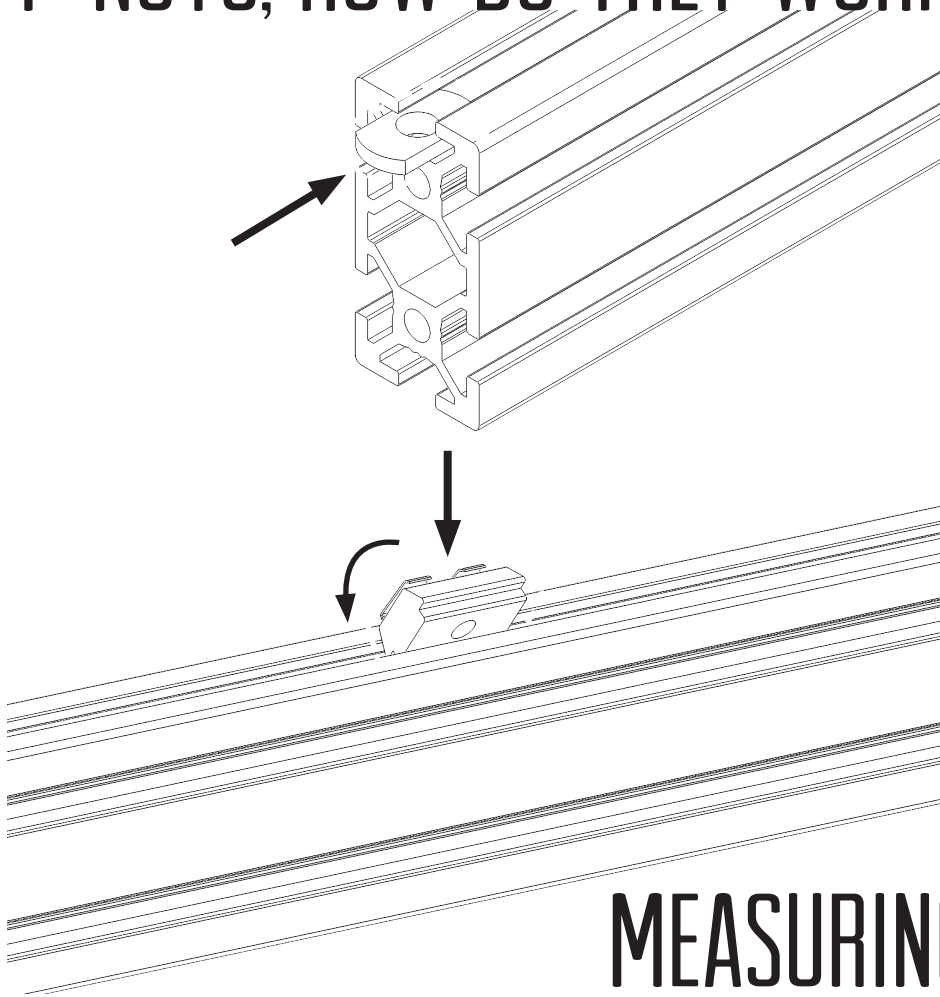

T-nuts are an essential part of assembling the Gigabot®. These are inserted into the aluminum extrusion in order to fasten parts to the frame.

Post assembly T-nuts are also used. These hold their positions well without sliding around, and are useful when installing retrofits.

MEASURING AND MARKING

There are parts of the instructions that suggest marking spots on the Gigabot® to properly place parts. When marking, be sure to only use a pencil--using a permanent marker will leave unsightly marks on the metal!



BUILD GUIDE

BILL OF MATERIALS

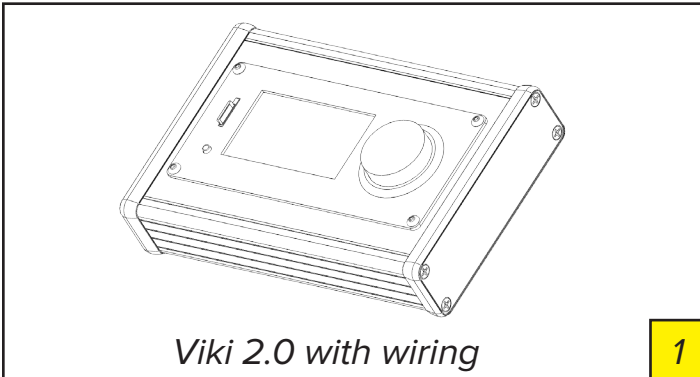

TOOLS YOU'LL NEED

- #1 PHILLIPS HEAD SCREWDRIVER

A : VIKI REPLACEMENT

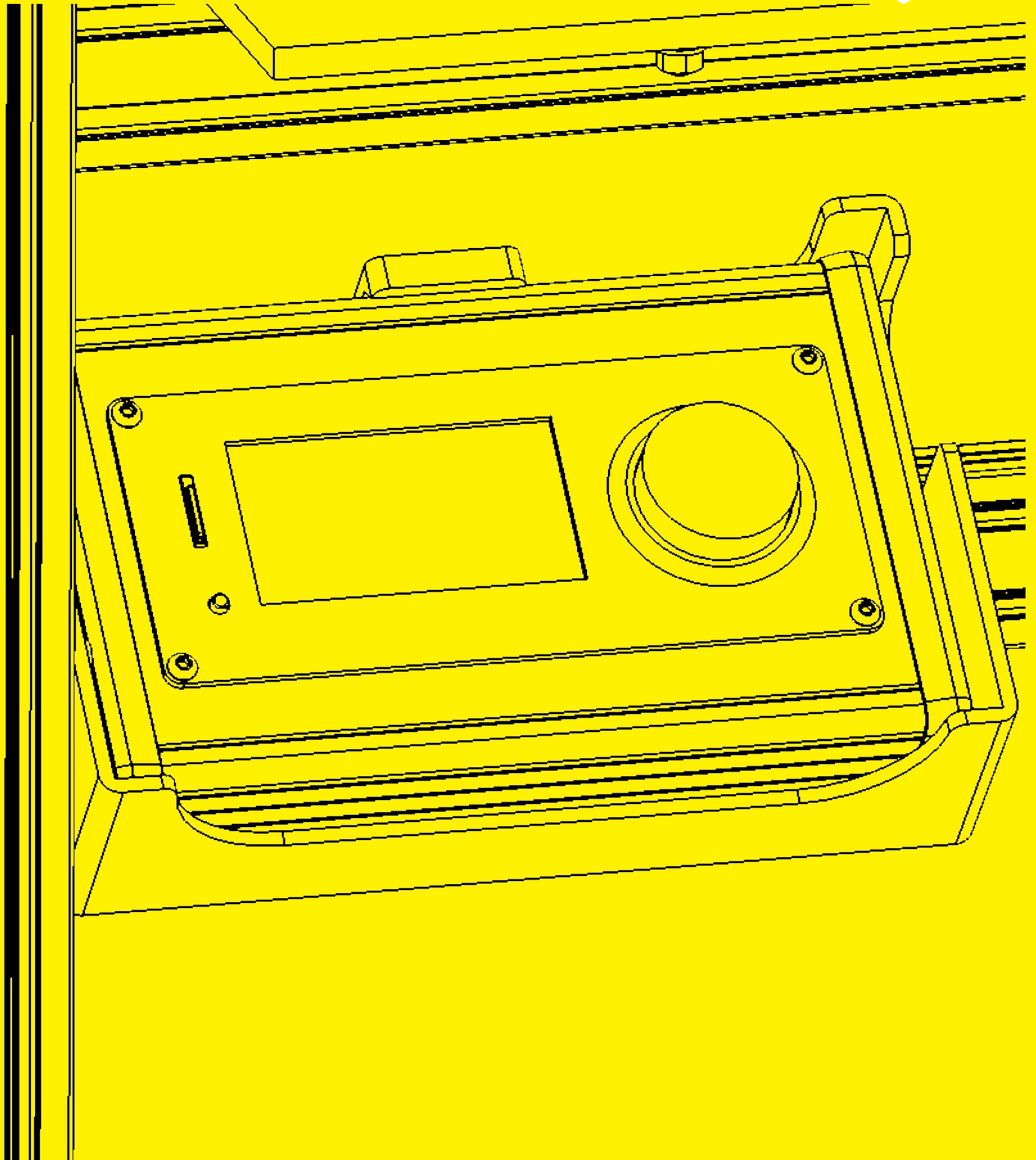

WARNING

PLEASE be sure that you have turned off and unplugged your Gigabot before attempting any modifications!

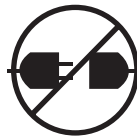

A2



In electrical box, disconnect and remove Viki wires

Refer to Azteeg wiring schematic if needed

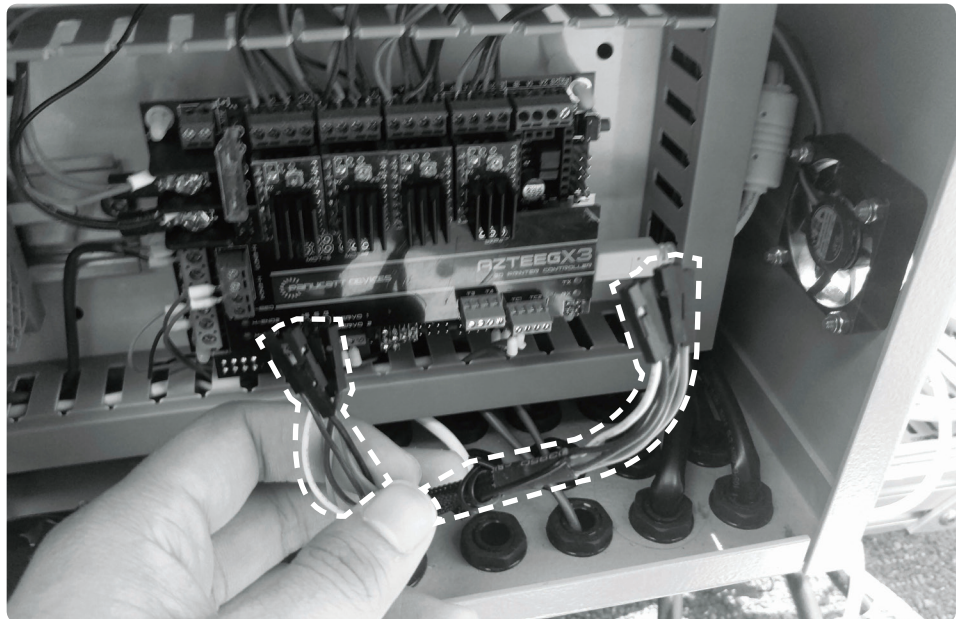

A3

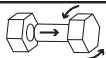

Unscrew and remove cable grommet cap with washer for Viki cables on electrical box





A4



Completely remove Viki wires from electrical box



A5

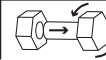

Unscrew and remove 4x screws on enclosure end plate with cable grommet using a Phillips head #1 screwdriver



A6



Remove enclosure end plate with cable grommet

A7



Slide out enclosure plate with Viki attached

If too tight, loosen screws on other enclosure end plate to relieve pressure, or remove altogether

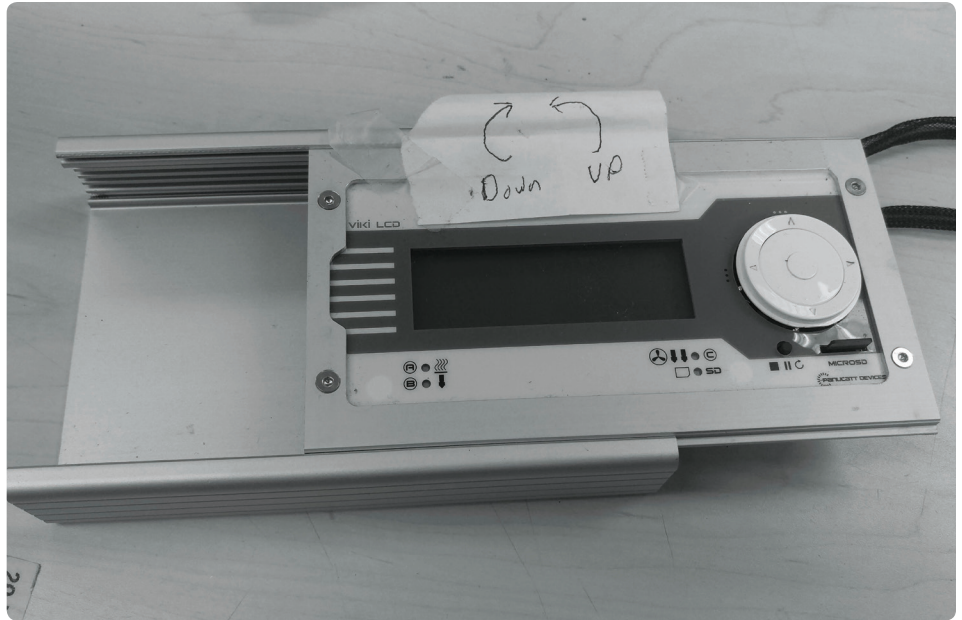

A8

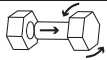

Unscrew and remove cable grommet cap with washer for Viki cables from Viki enclosure



A9

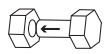

Slide enclosure plate with connected Viki 2.0 into enclosure

Don't forget to insert foam cube



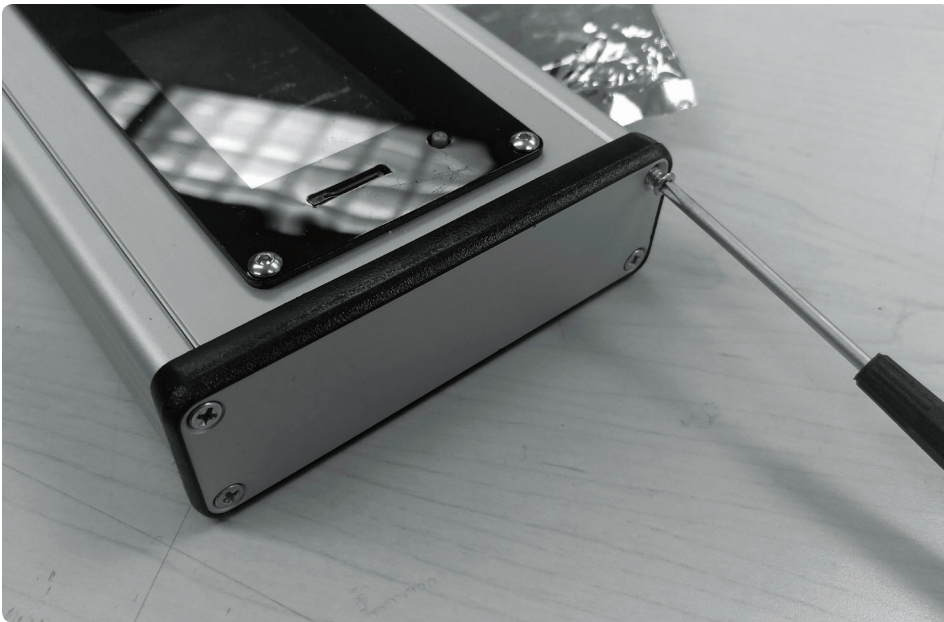

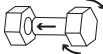
A10  

If left enclosure end plate was removed, replace it now



A11 

Before replacing end plate with grommet, reinsert rubber washer

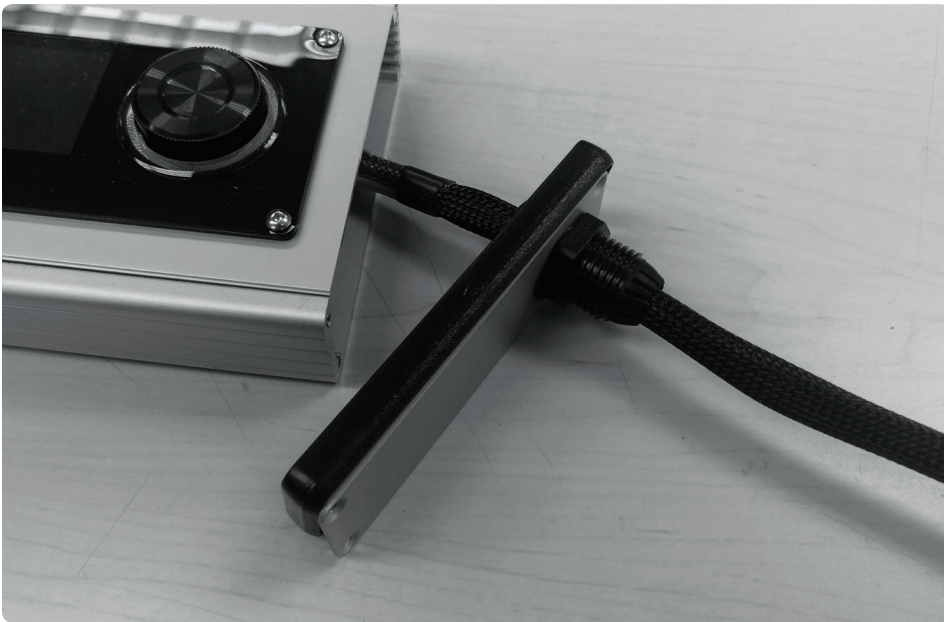

A12 

Route wiring through enclosure end plate grommet

Route wiring in small bundles if needed

A13



Replace enclosure end plate with cable grommet

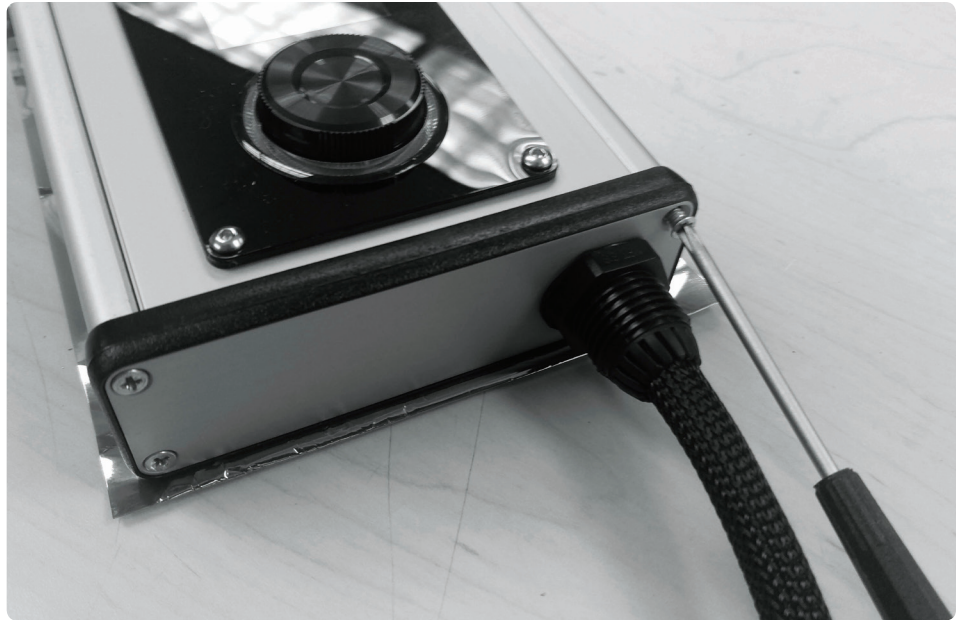

A14



Replace grommet cap



Washer may pop out while routing--press back into place if needed. Route wires in small bundles if needed

A15

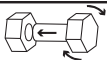

Tighten grommet





A16 
Replace washer in electrical
box grommet

*For illustrative purposes,
this has been shown on a
different grommet*

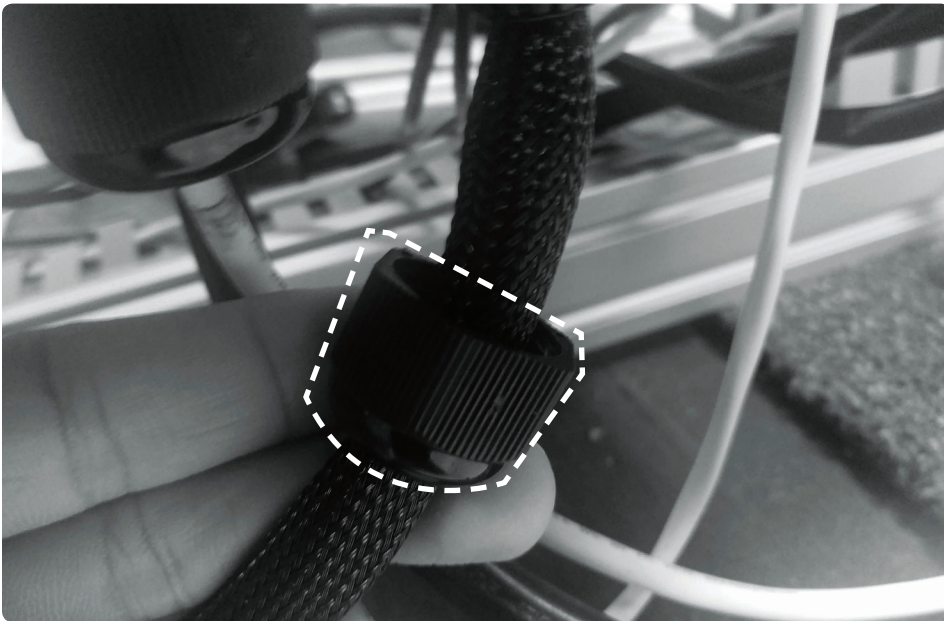

A17 
Replace other grommet cap
onto wire bundle

*Route wires in small
bundles if needed*

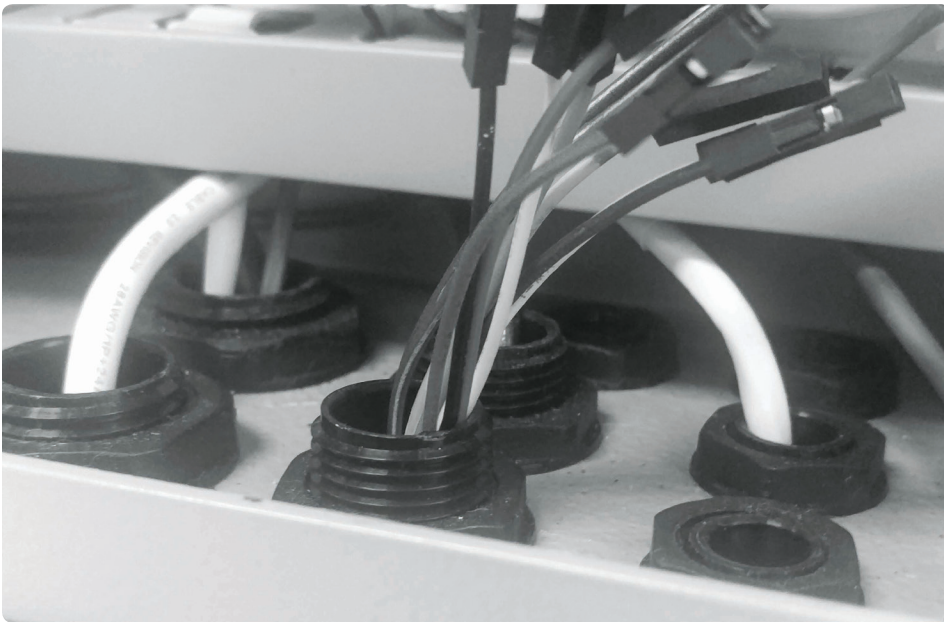

A18 
Route wires through
electrical box grommet

*Route wires in small
bundles if needed*

A19

Wire Viki 2.0 to Azteeg according to diagram

Check “References & Documents” page for links to more diagrams

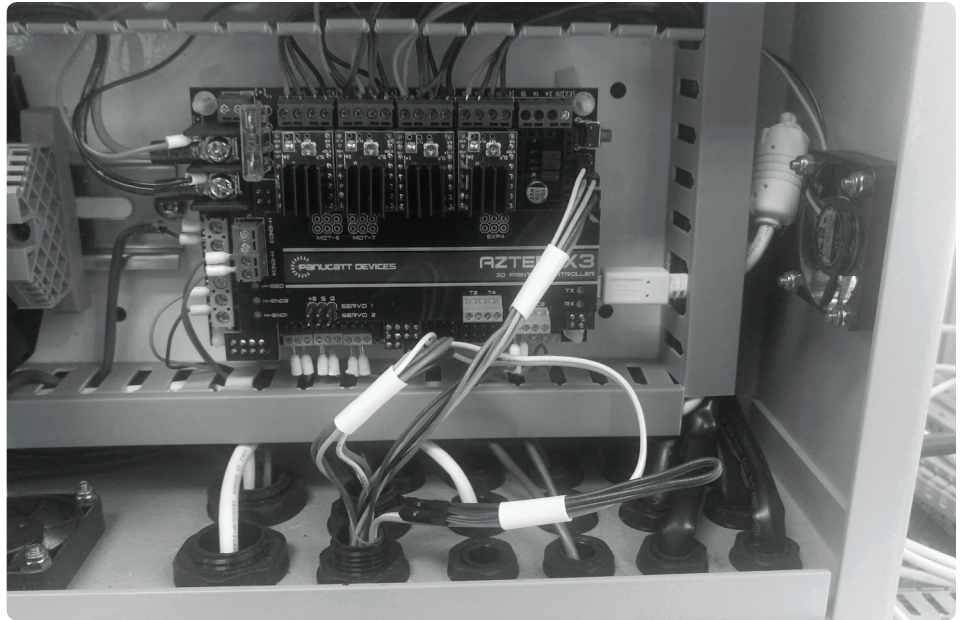

A20

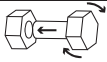

Tighten grommet cap

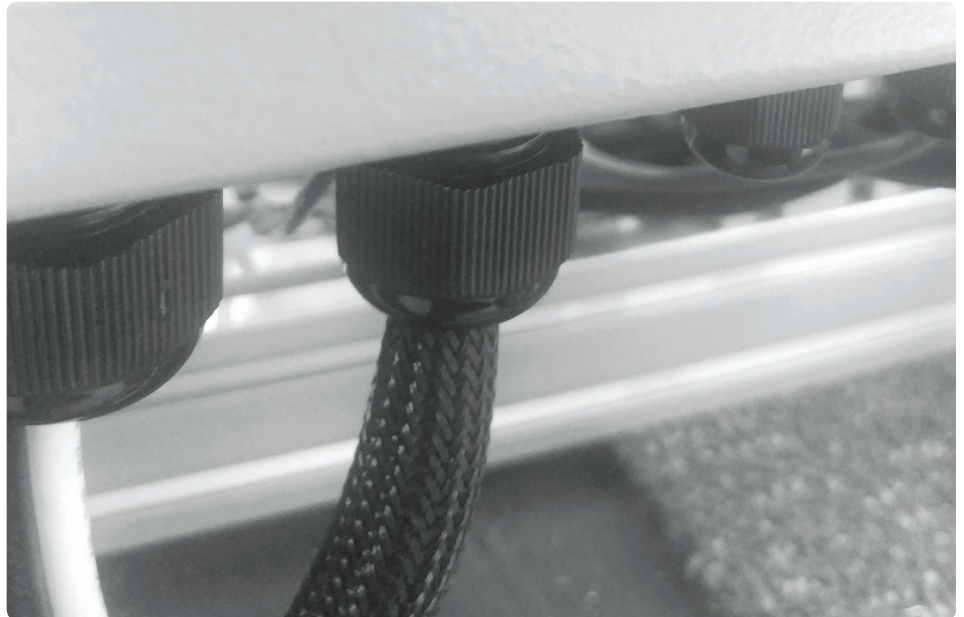

DOUBLE-CHECK YOUR WORK :

Please look over your completed kit and make sure everything has been assembled correctly. If you have further questions, please refer to the video instructions (search “re3D Tech” on YouTube and find “Viki 2.0 Installation” video) or contact us through the channels listed in the conclusion.

NOW IS A GOOD STOPPING POINT...

Acquire beverage of
your choice

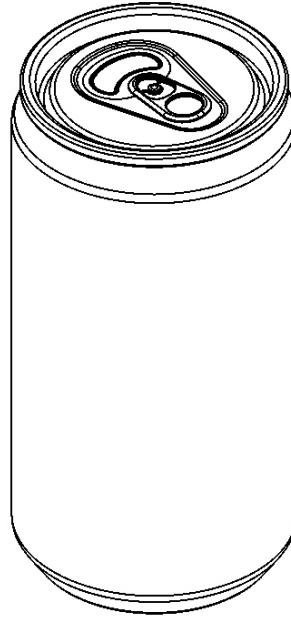

Actuate pull tab

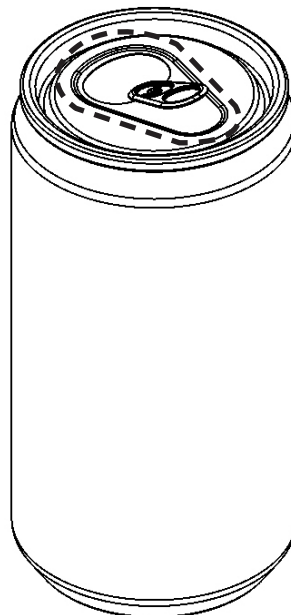

Consume

CONCLUSION

CONGRATULATIONS! YOU HAVE NOW COMPLETED THE VIKI 2.0 INSTALLATION RETROFIT ON YOUR GIGABOT®.

We are confident that you will find this upgrade very helpful in your every day use of the Gigabot®, but please do not hesitate to contact us for any further issues or questions. Feedback on assembly instructions, support, and other aspects of your experience are welcome. Reach out to us at:

WIKI : wiki.re3d.org

EMAIL : support@re3d.org

PHONE : 512-730-0033

Happy printing!

THINK BIG, PRINT HUGE!

From the re:3D Inc.® team

REFERENCES & DOCUMENTS

**VIKI 2.0 INSTALLATION
MANUAL PDF :** http://wiki.re3d.org/index.php?title=Retrofit_Instructions

**re:3D Inc.® YouTube
CHANNEL :** <https://www.youtube.com/user/GigaBot3D>

**GIGABOT® AZTEEG
DIAGRAM (bottom of
page) :** http://wiki.re3d.org/index.php?title=Retrofit_Instructions

**PANUCATT VIKI LCD
DIAGRAMS AND
SUPPORT FILES :** <http://panucattdevices.freshdesk.com/support/solutions/folders/1000183232>

WIRING : GIGABOT® WITH WIKI 2 & AZTEEG 2.0

For other configurations, please check our Wiki site, linked in the previous page.

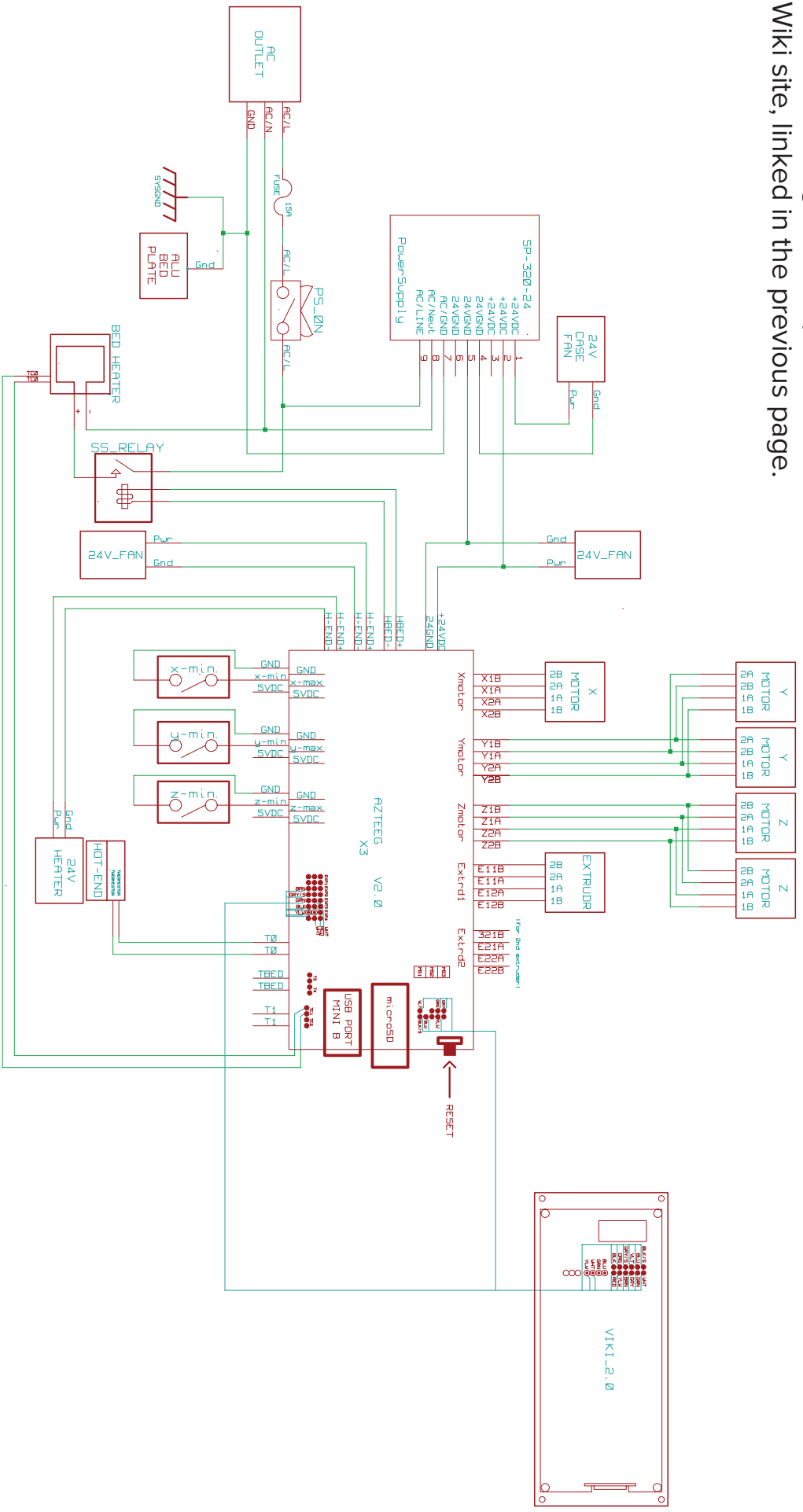



re:3D Inc.® | re3d.org | support@re3d.org